

## Eccentric Mounting Bushings • for lateral plungers, smooth - INCH EH 2B150.



### Product Description

The eccentric is used in conjunction with smooth lateral plungers EH 2B150. for positioning or clamping workpieces with large tolerances.

### Material

**Body**  
• Steel, blackened

### Assembly

Mounting and position determination by means of clamping with threaded pin.

### Drawing

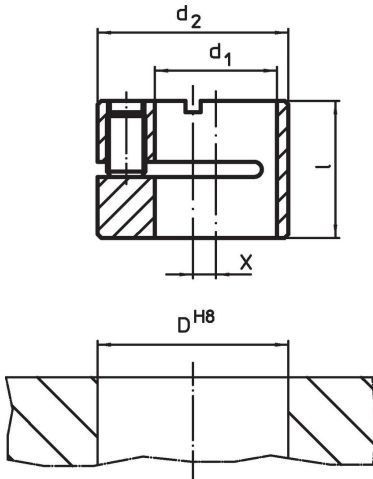

### Order information

d <sub>1</sub> H8	d <sub>2</sub> h9	Dimensions		Location hole D H8 [in]	[oz]	Art. No.
		l	x			
1/4	1/2	0.390	0.079	1/2	0.211	<a href="#">2B150.0806</a>
7/16	11/16	0.469	0.079	11/16	0.378	<a href="#">2B150.0810</a>
1/2	3/4	0.547	0.079	3/4	0.499	<a href="#">2B150.0812</a>
5/8	1	0.705	0.118	1	1.285	<a href="#">2B150.0816</a>

### Application example

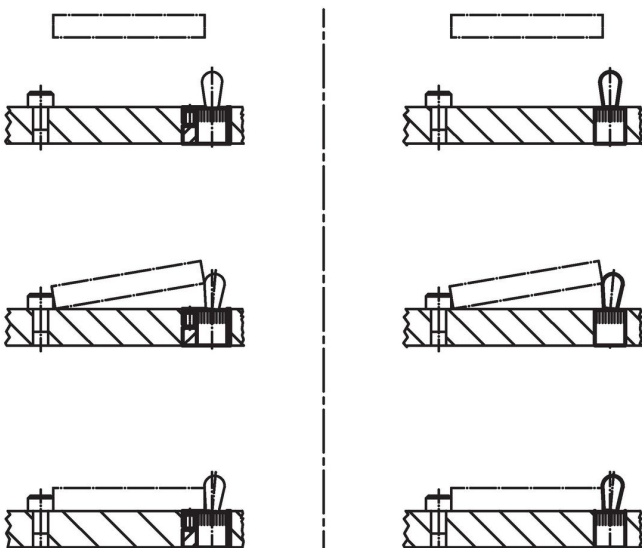

## Compliance

### RoHS compliant

Compliant according to Directive 2011/65/EU and Directive 2015/863.

### Does not contain SVHC substances

No SVHC substances with more than 0.1% w/w contained - SVHC list [REACH] as of 23.01.2024.

### Does not contain Proposition 65 substances

No Proposition 65 substances included.

<https://www.P65Warnings.ca.gov/>

### Free from Conflict Minerals

This product does not contain any substances designated as "conflict minerals" such as tantalum, tin, gold or tungsten from the Democratic Republic of Congo or adjacent countries.