

Hinges • stainless steel, elongated on one side

EH 25162.

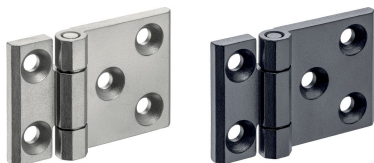

Product Description

These hinges from stainless steel are characterised by the compact design. The hinge pins are form-fit pressed and are therefore suitable for use in case of strong vibrations and shocks.

Appropriate friction pairings of the hinge components and the lubrication reduce abrasion to a minimum.

The version with centering steps avoids lateral slipping under high loads and thus protects the fixing screws from unacceptable lateral forces.

Material

Body

- Stainless steel 1.4405, dull blasted
- Stainless steel 1.4405, plastic-coated, black similar to RAL 9005, structure matt

Axis

- Stainless steel

Drawing

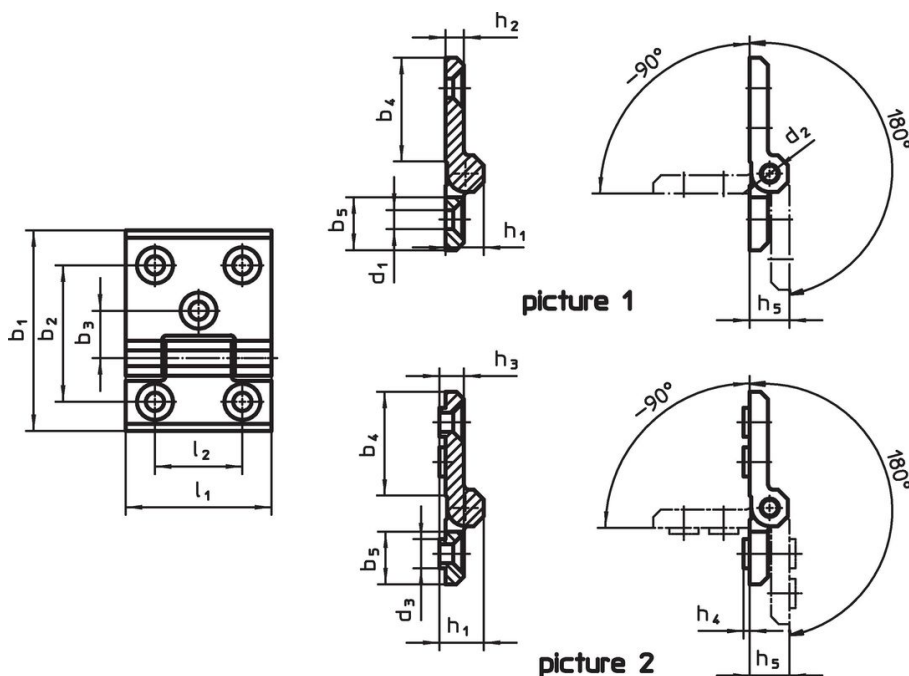

Order information

Dimensions																[g]	Art. No.
b ₁	l ₁	b ₂	b ₃	b ₄	b ₅	d ₁	d ₂	d ₃	h ₁	h ₂	h ₃	h ₄	h ₅	l ₂			
[mm]																	
one-sided with additional mounting hole – picture 1, dull blasted																	
63	50	43	15.0	34	21.0	6.3	6	9.5	12.5	6	6.5	2	13	30	135	25162.0055	
90	60	63	22.5	56	25.5	8.3	8	12.5	16.0	8	8.5	3	17	36	309	25162.0085	
120	80	85	30.0	75	36.0	10.3	10	14.5	20.0	10	10.5	4	21	50	677	25162.0015	
one-sided with additional mounting hole – picture 1, black																	
63	50	43	15.0	34	21.0	6.3	6	9.5	12.5	6	6.5	2	13	30	135	25162.0155	
90	60	63	22.5	56	25.5	8.3	8	12.5	16.0	8	8.5	3	17	36	309	25162.0185	
120	80	85	30.0	75	36.0	10.3	10	14.5	20.0	10	10.5	4	21	50	677	25162.0115	
one-sided with additional mounting hole and centring inserts – picture 2, dull blasted																	
63	50	43	15.0	34	21.0	6.3	6	9.5	12.5	6	6.5	2	13	30	142	25162.0060	
90	60	63	22.5	56	25.5	8.3	8	12.5	16.0	8	8.5	3	17	36	317	25162.0090	
120	80	85	30.0	75	36.0	10.3	10	14.5	20.0	10	10.5	4	21	50	690	25162.0020	

Dimensions																Art. No.
b ₁	l ₁	b ₂	b ₃	b ₄	b ₅	d ₁	d ₂	d ₃	h ₁	h ₂	h ₃	h ₄	h ₅	l ₂		
one-sided with additional mounting hole and centring inserts – picture 2, black																
63	50	43	15.0	34	21.0	6.3	6	9.5	12.5	6	6.5	2	13	30	142	25162.0160
90	60	63	22.5	56	25.5	8.3	8	12.5	16.0	8	8.5	3	17	36	317	25162.0190
120	80	85	30.0	75	36.0	10.3	10	14.5	20.0	10	10.5	4	21	50	690	25162.0120

Compliance

RoHS compliant

Compliant according to Directive 2011/65/EU and Directive 2015/863.

Does not contain SVHC substances

No SVHC substances with more than 0.1% w/w contained - SVHC list [REACH] as of 23.01.2024.

Does not contain Proposition 65 substances

No Proposition 65 substances included.

<https://www.P65Warnings.ca.gov/>

Free from Conflict Minerals

This product does not contain any substances designated as "conflict minerals" such as tantalum, tin, gold or tungsten from the Democratic Republic of Congo or adjacent countries.