

Palm Grips • DIN 6335 grey cast iron, plastic-coated EH 24620.



Product Description

These palm grips are manufactured according to DIN 6335.

Material

Handle

- Grey cast iron GG 20, plastic-coated, orange similar to RAL 2004
- Grey cast iron GG 20, plastic-coated, black similar to RAL 9005

Drawing

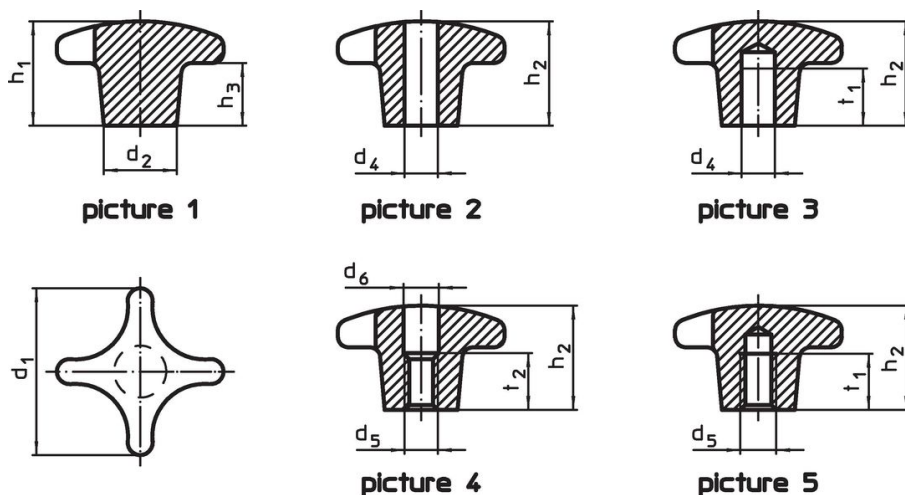

Order information

d ₁	d ₂	Dimensions				h ₂	t ₁	[g]	Art. No.
		d ₄ H7	d ₅	[mm]					
with smooth blind hole, form C – picture 3, orange									
40	14	8	–	–	25	15	62	24620.0540	
50	18	10	–	–	32	18	106	24620.0550	
63	20	12	–	–	40	22	201	24620.0563	
80	25	16	–	–	50	28	353	24620.0580	
with smooth blind hole, form C – picture 3, black									
40	14	8	–	–	25	15	62	24620.0640	
50	18	10	–	–	32	18	106	24620.0650	
63	20	12	–	–	40	22	201	24620.0663	
80	25	16	–	–	50	28	353	24620.0680	
with threaded blind hole, form E – picture 5, orange									
40	14	–	M 8	–	25	15	56	24620.0541	
50	18	–	M10	–	32	18	105	24620.0551	
63	20	–	M12	–	40	22	198	24620.0564	
80	25	–	M16	–	50	28	369	24620.0581	
with threaded blind hole, form E – picture 5, black									
40	14	–	M 8	–	25	15	56	24620.0641	
50	18	–	M10	–	32	18	105	24620.0651	
63	20	–	M12	–	40	22	198	24620.0664	
80	25	–	M16	–	50	28	369	24620.0681	

Application example

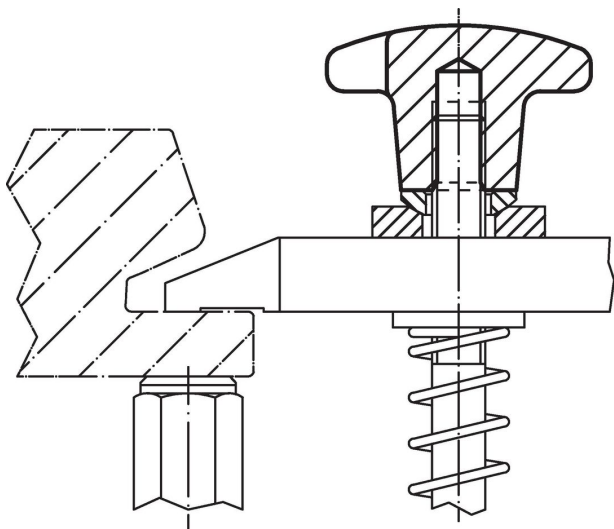

Compliance

RoHS compliant

Compliant according to Directive 2011/65/EU and Directive 2015/863.

Does not contain SVHC substances

No SVHC substances with more than 0.1% w/w contained - SVHC list [REACH] as of 23.01.2024.

Does not contain Proposition 65 substances

No Proposition 65 substances included.

<https://www.P65Warnings.ca.gov/>

Free from Conflict Minerals

This product does not contain any substances designated as "conflict minerals" such as tantalum, tin, gold or tungsten from the Democratic Republic of Congo or adjacent countries.