

## Retaining Latches · wing grip, one-sided

EH 24101.



### Product Description

To be used for door locking, drawers and as handling aid etc.  
The retaining catch is indexing 4 x 90°.

### Material

#### Flange

- Zinc die-cast, plastic coated, black

#### Lever

- Zinc die-cast, plastic coated, silver, similar to RAL 9006, matt structure
- Zinc die-cast, plastic coated, black, similar to RAL 9005, matt structure

#### Inner parts

- Zinc die-cast
- Steel
- plastic

### Drawing

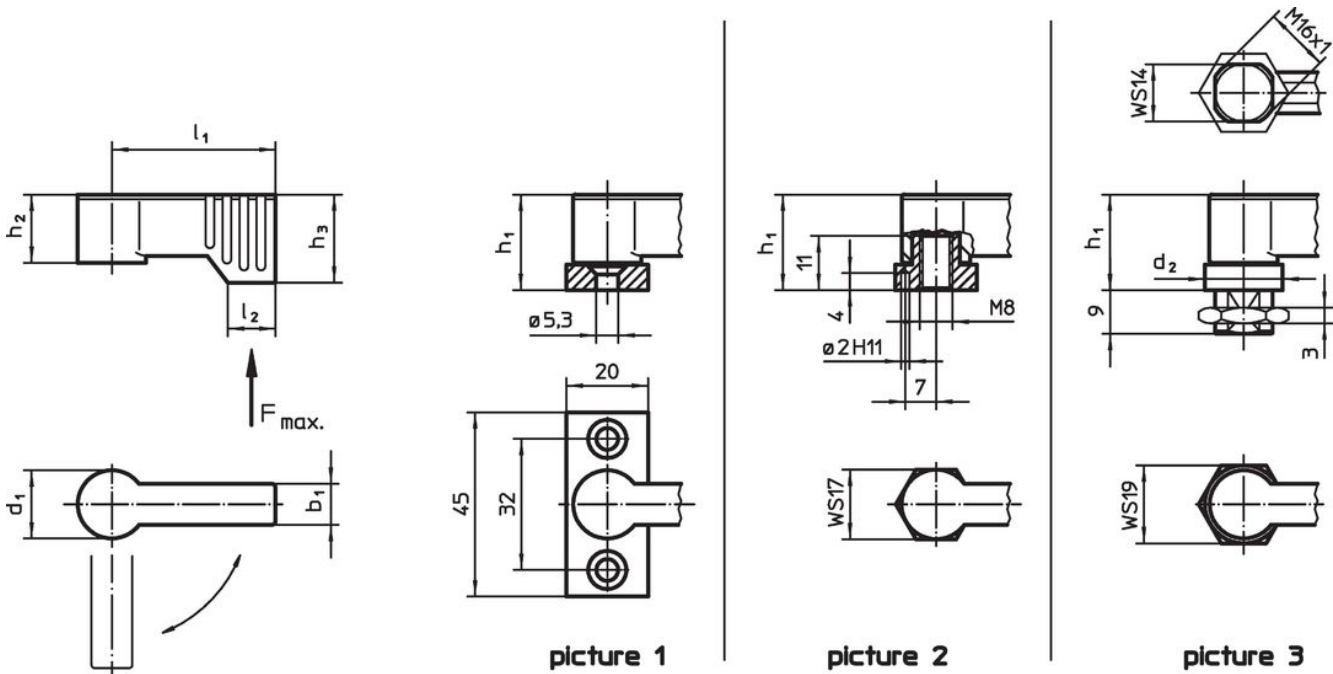

Order information

d <sub>1</sub>	l <sub>1</sub>	b <sub>1</sub>	Dimensions				h <sub>3</sub> min.	l <sub>2</sub>	Load capacity F max. [N]	 [g]	Art. No.
			d <sub>2</sub>	h <sub>1</sub> ~ [mm]	h <sub>2</sub> ~						
<b>with mounting flange – picture 1, silver</b>											
17	40	10	–	22	16.5	21.5	11	450	75	24101.0201	
17	55	10	–	22	16.5	21.5	11	450	83	24101.0204	
<b>with mounting flange – picture 1, black</b>											
17	40	10	–	22	16.5	21.5	11	450	75	24101.0202	
17	55	10	–	22	16.5	21.5	11	450	83	24101.0203	
<b>with female thread – picture 2, silver</b>											
17	40	10	–	22	16.5	21.5	11	450	57	24101.0231	
17	55	10	–	22	16.5	21.5	11	450	65	24101.0234	
<b>with female thread – picture 2, black</b>											
17	40	10	–	22	16.5	21.5	11	450	57	24101.0232	
17	55	10	–	22	16.5	21.5	11	450	65	24101.0233	
<b>with male thread – picture 3, silver</b>											
17	40	10	19	22	16.5	21.5	11	450	69	24101.0261	
17	55	10	19	22	16.5	21.5	11	450	76	24101.0264	
<b>with male thread – picture 3, black</b>											
17	40	10	19	22	16.5	21.5	11	450	69	24101.0262	
17	55	10	19	22	16.5	21.5	11	450	76	24101.0263	

Application example

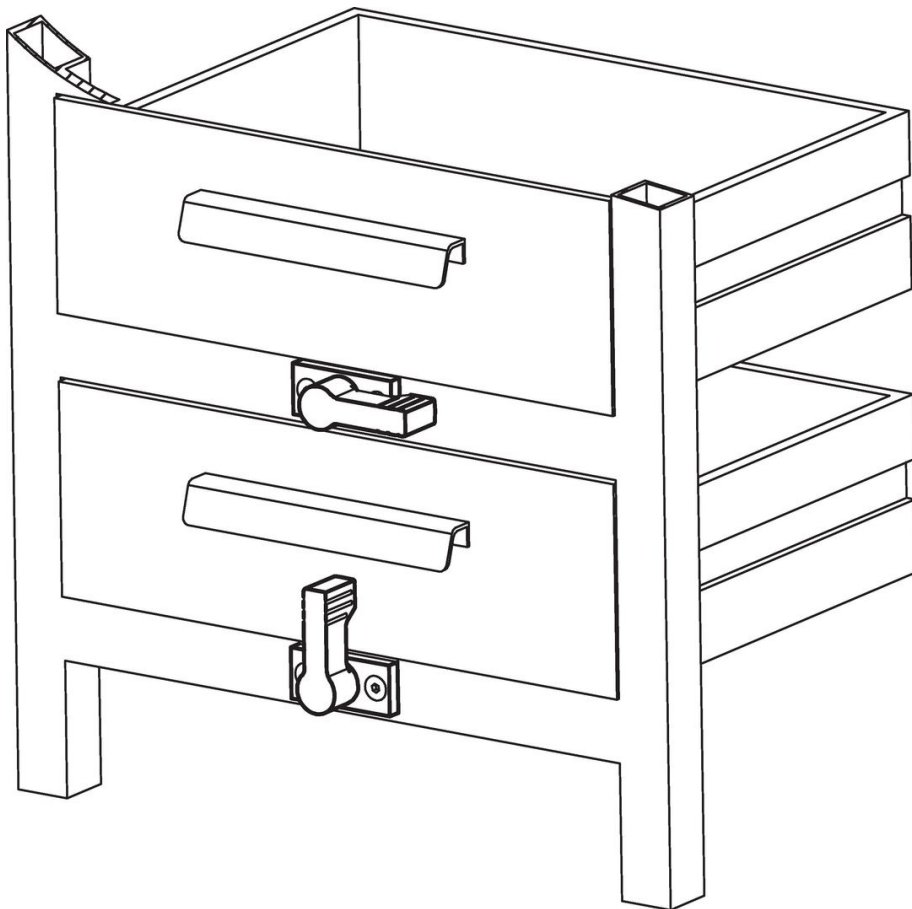

## Compliance

### RoHS compliant

Compliant according to Directive 2011/65/EU and Directive 2015/863.

### Does not contain SVHC substances

No SVHC substances with more than 0.1% w/w contained - SVHC list [REACH] as of 23.01.2024.

### Does not contain Proposition 65 substances

No Proposition 65 substances included.

<https://www.P65Warnings.ca.gov/>

### Free from Conflict Minerals

This product does not contain any substances designated as "conflict minerals" such as tantalum, tin, gold or tungsten from the Democratic Republic of Congo or adjacent countries.