

## Intermediate Elements

EH 23700.



### Product Description

#### Material

##### Body

- Steel, blackened

##### Wearing parts

- Heat-treated steel

##### Pull-rod

- Special steel

### Drawing



### Order information

a	b	c	Dimensions				[g]	Art. No.
			d	i	l	[mm]		
25	25	65	16	12.5	40	261	<a href="#">23700.0121</a>	
50	25	65	16	12.5	40	580	<a href="#">23700.0122</a>	
100	25	65	16	12.5	40	1201	<a href="#">23700.0123</a>	
30	30	78	22	14.0	50	468	<a href="#">23700.0161</a>	
60	30	78	22	14.0	50	1032	<a href="#">23700.0162</a>	
120	30	78	22	14.0	50	2149	<a href="#">23700.0163</a>	
240	30	78	22	14.0	50	4340	<a href="#">23700.0164</a>	

## Application example

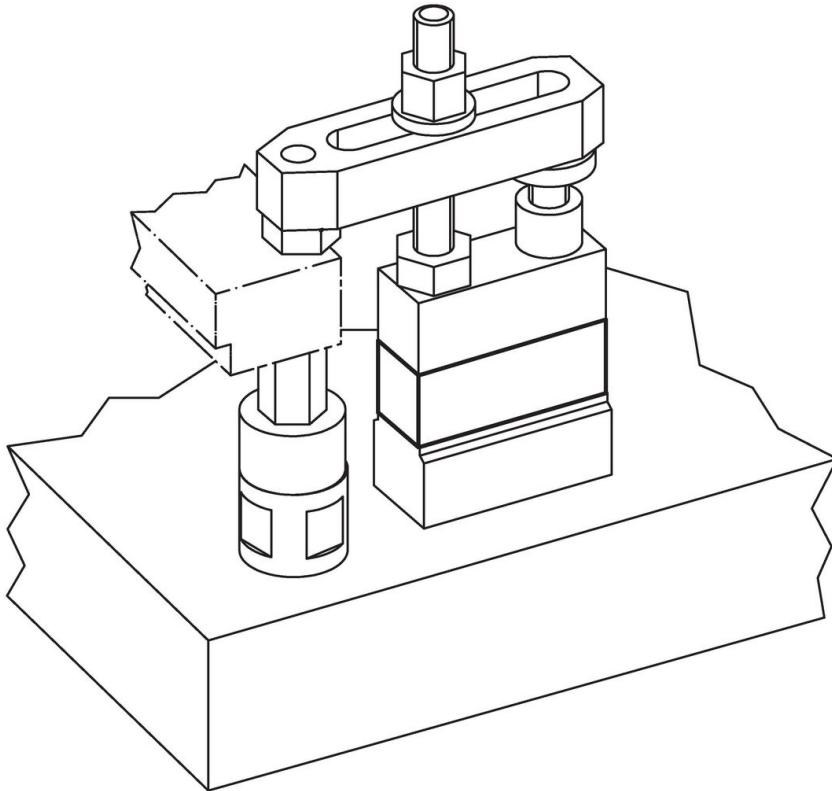

## Compliance

### RoHS compliant

Compliant according to Directive 2011/65/EU and Directive 2015/863.

### Does not contain SVHC substances

No SVHC substances with more than 0.1% w/w contained - SVHC list [REACH] as of 23.01.2024.

### Does not contain Proposition 65 substances

No Proposition 65 substances included.

<https://www.P65Warnings.ca.gov/>

### Free from Conflict Minerals

This product does not contain any substances designated as "conflict minerals" such as tantalum, tin, gold or tungsten from the Democratic Republic of Congo or adjacent countries.