

Screw Jacks

EH 23470.



Product Description

Trapezoidal self-locking thread, spindle with final safety device. The holders, which can be secured by means of the T-slots, make it possible to tighten the jacks so that they will not slip out of position when a workpiece is changed. They also allow to fit screw jacks to vertical clamping surfaces. Screw jacks are frequently used for supporting workpieces. Use of the self-aligning cap ensures a correctly aligned bearing surface. Using the centering plate as an intermediate element, it is possible to fit a number of screw jacks sizes 52, 70 and 100 together one above the other.

Material

Caps

- Steel, case-hardened, blackened

Holder

- Steel, blackened

Screw Jacks

- Steel 1.0503 varnished



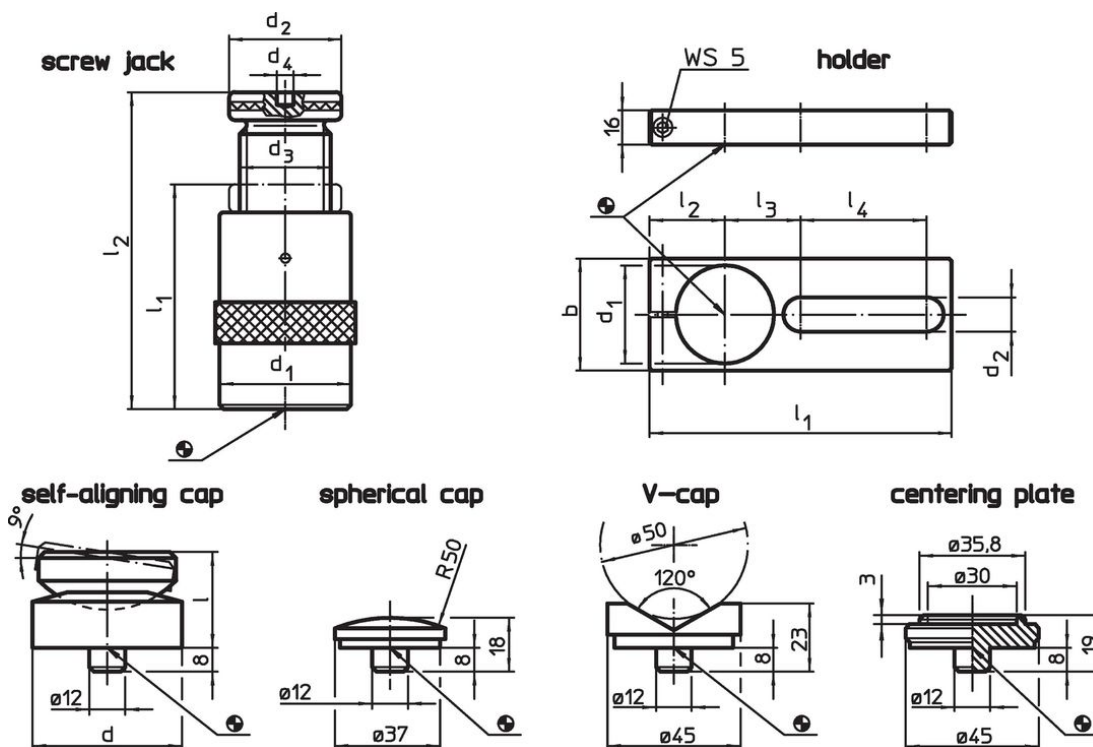



Drawing



Order information

Clamping height max. [mm]	l ₁ min.	Dimensions				Load capacity [kN]	[g]	Art. No.
		d ₁ [mm]	d ₂	d ₃	d ₄ [mm]			
screw jack								
50	38	31	31	Tr 20 x 4	–	15	191	23470.0005
52	42	50	50	Tr 30 x 4	12	60	539	23470.0006
70	50	50	50	Tr 30 x 4	12	60	645	23470.0007
100	70	50	50	Tr 30 x 4	12	60	900	23470.0010
140	100	69	69	Tr 40 x 7	12	100	2614	23470.0014
210	140	80	70	Tr 50 x 8	12	170	4336	23470.0021
300	190	100	80	Tr 65 x 10	12	350	9680	23470.0030

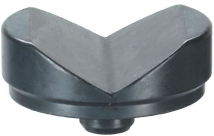
Accessories

	Dimensions										For screw jacks [mm]	 [g]	Art. No.	
	d	d ₁	b	d ₂	l	l ₁	l ₂	l ₃	l ₄	[mm]				
holder														
	-	31	40	18.5	-	175	30	35	90		50	516	23470.0232	
	-	50	60	20.5	-	190	38	46	90		52/ 70/100	879	23470.0250	
	-	69	80	24.5	-	210	48	54	90		140	1279	23470.0270	
self-aligning cap														
	50	-	-	-	32	-	-	-	-		52/ 70/100	399	23470.0350	
	65	-	-	-	35	-	-	-	-		140/210	716	23470.0365	
spherical cap														
	-	-	-	-	-	-	-	-	-		52/ 70/100/140/210/300	75	23470.0171	
V-cap														
	-	-	-	-	-	-	-	-	-		52/ 70/100/140/210/300	138	23470.0172	
centering plate														
	-	-	-	-	-	-	-	-	-		52/ 70/100	107	23470.0170	

Compliance

For detailed compliance information please select the desired article number.