

## Eccentric Clamping Washers

EH 23270.



### Product Description

The eccentric clamping washers are especially suitable for the clamping of raw parts, e.g. cut-off portions, cast iron parts and forgings.

### Material

#### Eccentric screw

- Steel

#### Body

- Steel, case-hardened

### More information

#### Notes

The head of the eccentric screw can slightly protrude from the body ( $h_1$ ).

### Drawing

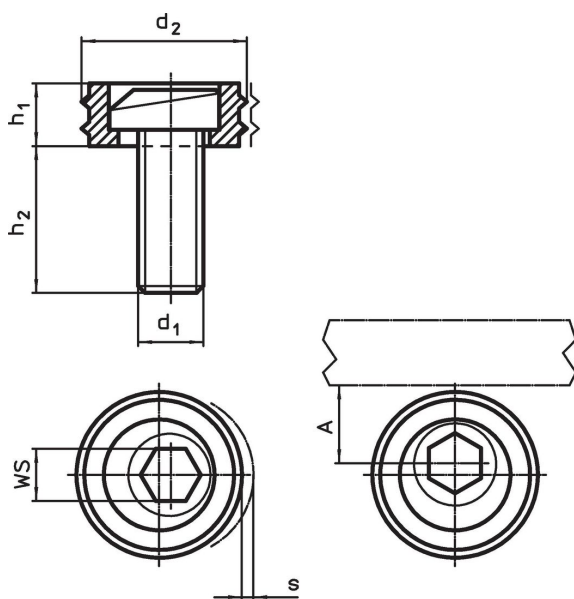

### Order information

$d_1$	$d_2$	Dimensions			A	WS	Clamping force max. [kN]	Tightening torque max. [Nm]	[g]	Art. No.
		$h_1$	$h_2$	s						
		[mm]			[mm]	[mm]				
M10	20.6	6.4	16.0	1.6	10.3	7	9.0	26	23	<a href="#">23270.0210</a>
M12	25.4	9.6	22.5	2.0	12.7	8	17.8	88	41	<a href="#">23270.0212</a>
M16	30.1	12.7	26.8	2.5	15.0	12	26.7	135	92	<a href="#">23270.0216</a>

### Application example

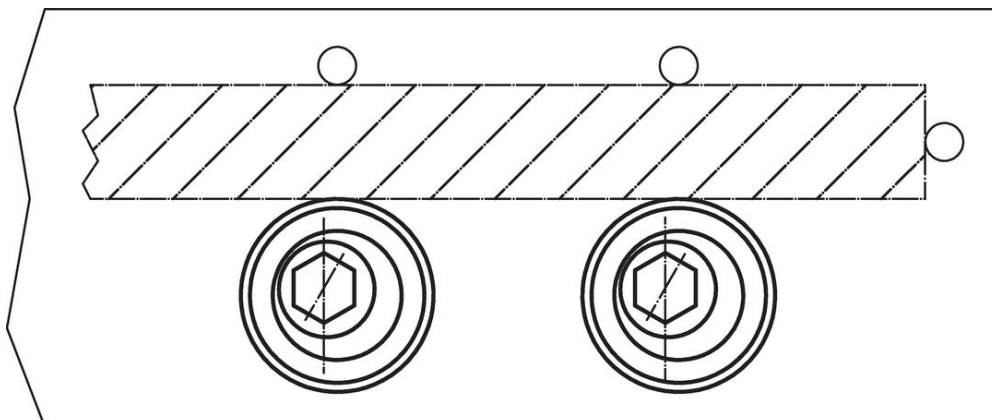

## Compliance

### RoHS compliant

Compliant according to Directive 2011/65/EU and Directive 2015/863.

### Does not contain SVHC substances

No SVHC substances with more than 0.1% w/w contained - SVHC list [REACH] as of 27.06.2024.

### Does not contain Proposition 65 substances

No Proposition 65 substances included.

<https://www.P65Warnings.ca.gov/>

### Free from Conflict Minerals

This product does not contain any substances designated as "conflict minerals" such as tantalum, tin, gold or tungsten from the Democratic Republic of Congo or adjacent countries.