

Down-Hold Clamps · without clamping lever, with support EH 23210.

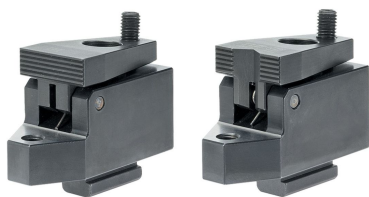

Product Description

By tightening the ball-ended thrust screw the workpiece is simultaneously pressed towards the stops and fixture plate. The favourable leverage enables high horizontal clamping forces. When using T-Nuts EH 23010. / EH 23020. (DIN 508) they can also be applied to other slot sizes.

Material

- Steel, case-hardened, blackened, ground

More information

References

The integrated support is equipped with a locating thread to fit for example screwed rest buttons EH 22690., self-aligning pads EH 22730. / EH 22740.

Further products

- Nuts for T-Slots, DIN 508
- Nuts for T-Slots, extended

Drawing

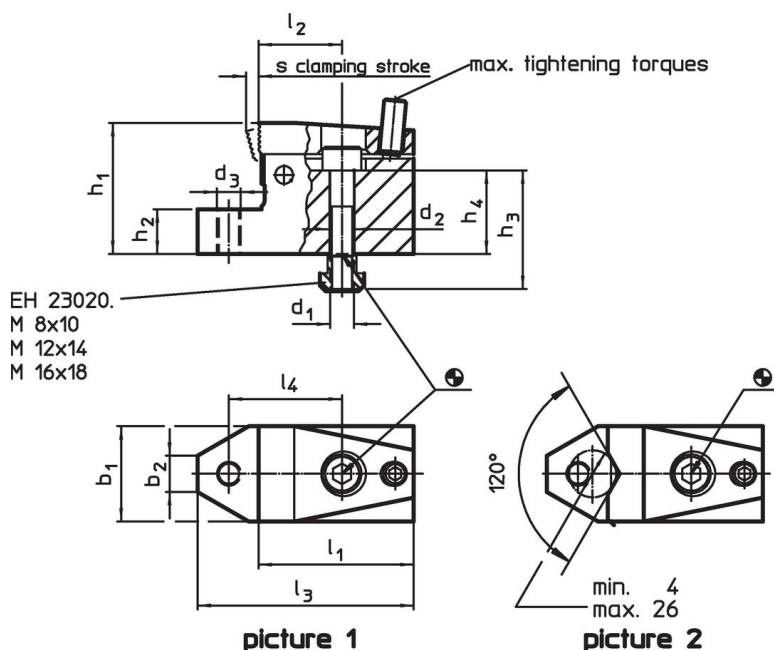

Order information

T-slot size	d ₁	d ₂	d ₃	b ₁	b ₂	Dimensions								s	Clamping force horizontal max. [kN]	Tightening torque max. [Nm]	Weight [g]	Art. No.
						h ₁	h ₂ ±0.01	h ₃ ~	h ₄ ~	l ₁	l ₂	l ₃	l ₄					
[mm]						[mm]												
with flat clamping jaw – picture 1																		
10	M 8	8.4	M 8	32	12.1	44	15	40	28	52	28	72.5	38	3	7.0	3	566	23210.0551
14	M12	13.0	M12	48	16.0	53	15	45	27	72	40	100.0	55	4	15.0	9	1349	23210.0561
18	M16	17.0	M16	68	18.8	72	20	60	38	86	41	126.0	63	7	21.5	20	3000	23210.0571
with V-clamping jaw – picture 2																		
10	M 8	8.4	M 8	32	12.1	44	15	40	28	52	28	72.5	38	3	7.0	3	571	23210.0552
14	M12	13.0	M12	48	16.0	53	15	45	27	72	40	100.0	55	4	15.0	9	1340	23210.0562
18	M16	17.0	M16	68	18.8	72	20	60	38	86	41	126.0	63	7	21.5	20	3000	23210.0572

Application example



Compliance

RoHS compliant

Contains lead - compliant according to exceptions 6a / 6b / 6c.

Contains SVHC substances >0,1% w/w

Contains lead - SVHC list [REACH] as of 23.01.2024.

Contains Proposition 65 substances



Lead can cause cancer and reproductive harm from exposure
<https://www.P65Warnings.ca.gov/>

Free from Conflict Minerals

This product does not contain any substances designated as "conflict minerals" such as tantalum, tin, gold or tungsten from the Democratic Republic of Congo or adjacent countries.