

Clamps · with nose

EH 23180.



Product Description

This clamp (clamping claw) with nose is mainly used in mechanical clamping technology for clamping workpieces.

Material

- Heat-treated steel, tempered, blackened

Drawing

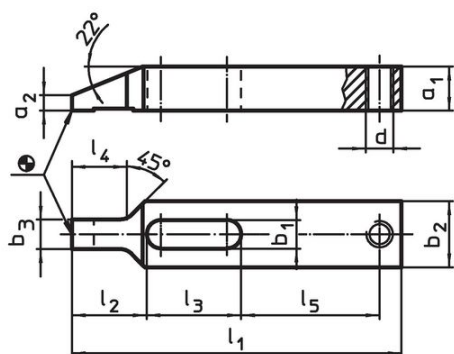

picture 1

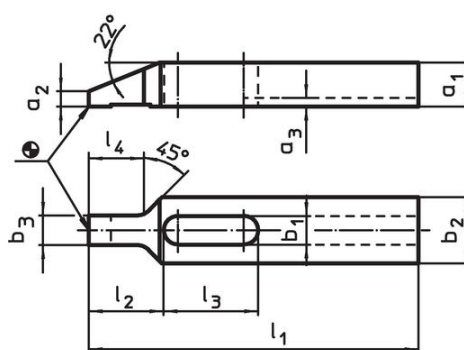

picture 2

Order information

Nominal dimension b ₁ [mm]	Dimensions											[g]	Art. No.
	l ₁	a ₁	a ₂	a ₃	b ₂	b ₃	d	l ₂	l ₃	l ₄	l ₅		
with thread for adjusting screw – picture 1													
6.6	80	8	2.5	–	15	7.5	M 6	17	23	13	34	54	23180.0107
9.0	100	12	4.0	–	20	9.5	M 8	22	29	17	42	133	23180.0109
11.0	125	15	5.0	–	25	11.5	M10	28	36	21	52	261	23180.0111
13.0	150	20	7.0	–	30	13.5	M12	34	43	25	63	504	23180.0113
17.0	175	25	9.0	–	35	15.5	M16	40	52	29	70	828	23180.0117
with keyway – picture 2													
6.6	80	8	2.5	2.5	15	7.5	–	17	23	13	–	50	23180.0207
9.0	100	12	4.0	3.0	20	9.5	–	22	29	17	–	127	23180.0209
11.0	125	15	5.0	3.5	25	11.5	–	28	36	21	–	251	23180.0211
13.0	150	20	7.0	4.0	30	13.5	–	34	43	25	–	488	23180.0213
17.0	175	25	9.0	4.5	35	15.5	–	40	52	29	–	812	23180.0217
22.0	225	35	15.5	5.5	50	19.5	–	52	62	33	–	2200	23180.0222
26.0	250	40	17.5	5.5	60	21.5	–	60	71	36	–	3340	23180.0226

Application example

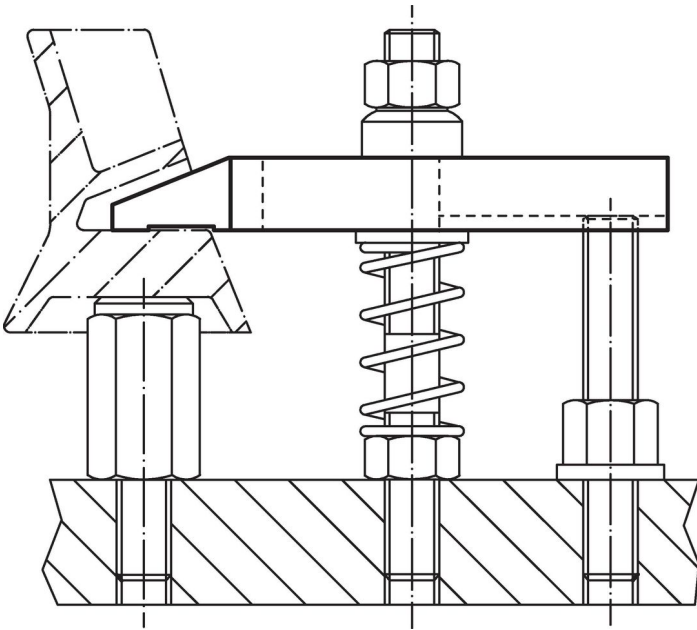

Compliance

RoHS compliant

Compliant according to Directive 2011/65/EU and Directive 2015/863.

Does not contain SVHC substances

No SVHC substances with more than 0.1% w/w contained - SVHC list [REACH] as of 27.06.2024.

Does not contain Proposition 65 substances

No Proposition 65 substances included.
<https://www.P65Warnings.ca.gov/>

Free from Conflict Minerals

This product does not contain any substances designated as "conflict minerals" such as tantalum, tin, gold or tungsten from the Democratic Republic of Congo or adjacent countries.