

Clamps • DIN 6316 with goose-neck EH 23160.



Product Description

This clamp (clamping claw) according to DIN 6316 with goose-neck is mainly used in mechanical clamping technology for clamping workpieces.

Material

- Heat-treated steel, varnished

Drawing

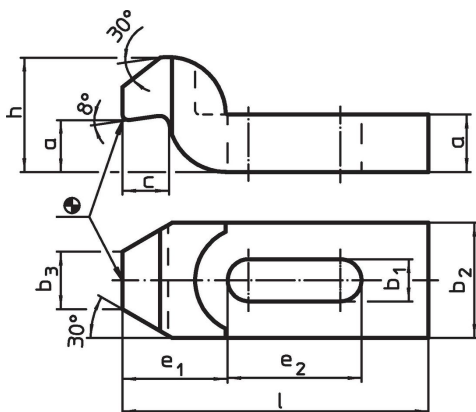

Order information

Nominal dimension b_1 [mm]	l	a	b_2	Dimensions					For screws		🔩 [g]	Art. No.
				b_3	c	e_1	e_2	h	[mm]	[in]		
6.6	60	10	20	10	8	20	20	20	M 6	1/4	81	23160.0007
9.0	80	12	25	12	9	25	25	24	M 8	5/16	165	23160.0009
11.0	100	15	30	15	12	32	32	30	M10	3/8	307	23160.0011
14.0	125	20	40	20	16	40	40	40	M12, M14	1/2	680	23160.0014
18.0	125	25	50	25	20	49	40	50	M16, M18	5/8	1059	23160.0018¹⁾
18.0	160	25	50	25	20	49	50	50	M16, M18	5/8	1356	23160.0019
22.0	160	30	60	30	24	55	55	60	M20	3/4	1937	23160.0022¹⁾
22.0	200	30	60	30	24	55	70	60	M20	3/4	2100	23160.0023
26.0	200	35	70	35	28	72	60	70	M24	1	3364	23160.0026¹⁾
26.0	250	35	70	35	28	72	80	70	M24	1	4115	23160.0027
33.0	250	40	80	40	40	91	80	80	M30	1 1/4	4500	23160.0034¹⁾
33.0	315	50	80	40	40	91	100	100	M30	1 1/4	8340	23160.0035

¹⁾ DIN standards do not include these dimensions.

Application example

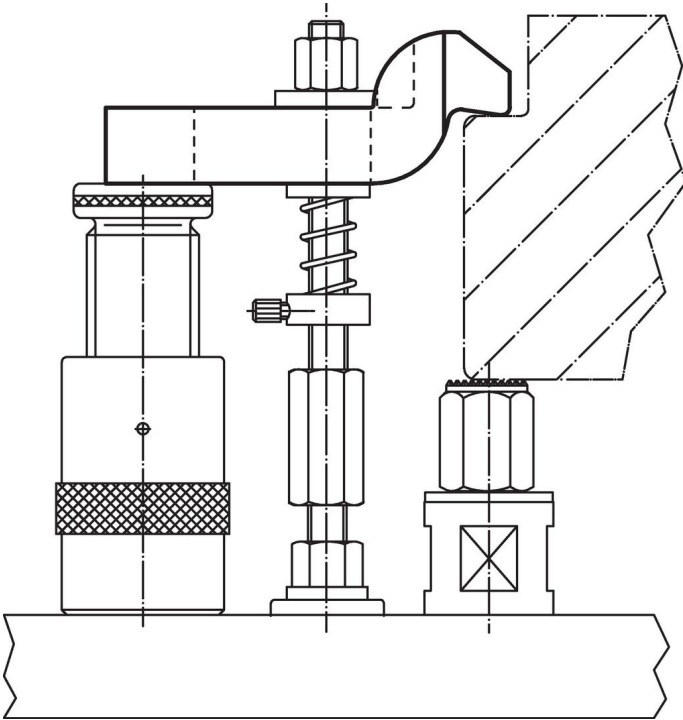

Compliance

RoHS compliant

Compliant according to Directive 2011/65/EU and Directive 2015/863.

Does not contain SVHC substances

No SVHC substances with more than 0.1% w/w contained - SVHC list [REACH] as of 27.06.2024.

Does not contain Proposition 65 substances

No Proposition 65 substances included.

<https://www.P65Warnings.ca.gov/>

Free from Conflict Minerals

This product does not contain any substances designated as "conflict minerals" such as tantalum, tin, gold or tungsten from the Democratic Republic of Congo or adjacent countries.