

## Clamps • DIN 6314 flat EH 23140.



### Product Description

This clamp (clamping claw) according to DIN 6314 is mainly used in mechanical clamping technology for clamping workpieces.

### Material

- Heat-treated steel, varnished

### Drawing



### Order information

Nominal dimension $b_1$ [mm]	l	a	Dimensions [mm]				For screws		[g]	Art. No.
			$b_2$	$b_3$	$e_1$	$e_2$	[mm]	[in]		
6.6	50	10	20	8	10	20	M 6	1/4	61	<a href="#">23140.0007</a>
9.0	60	12	25	10	13	22	M 8	5/16	112	<a href="#">23140.0009</a>
11.0	80	15	30	12	15	30	M10	3/8	228	<a href="#">23140.0011</a>
14.0	100	20	40	14	21	40	M12, M14	1/2	492	<a href="#">23140.0014</a>
14.0	125	20	40	14	21	50	M12, M14	1/2	623	<a href="#">23140.0015</a>
18.0	125	25	50	18	26	45	M16, M18	5/8	980	<a href="#">23140.0018</a>
18.0	160	25	50	18	26	65	M16, M18	5/8	1246	<a href="#">23140.0019</a>
22.0	160	30	60	22	30	60	M20, M22	3/4	1793	<a href="#">23140.0022</a>
22.0	200	30	60	22	30	80	M20, M22	3/4	2244	<a href="#">23140.0023</a>
26.0	200	30	70	26	35	80	M24	1	2617	<a href="#">23140.0026</a>
26.0	250	30	70	26	35	105	M24	1	3823	<a href="#">23140.0027</a>
33.0	250	40	80	34	45	100	M30	1 1/4	4980	<a href="#">23140.0034</a>
33.0	315	50	80	34	45	130	M30	1 1/4	7840	<a href="#">23140.0035</a>

## Application example

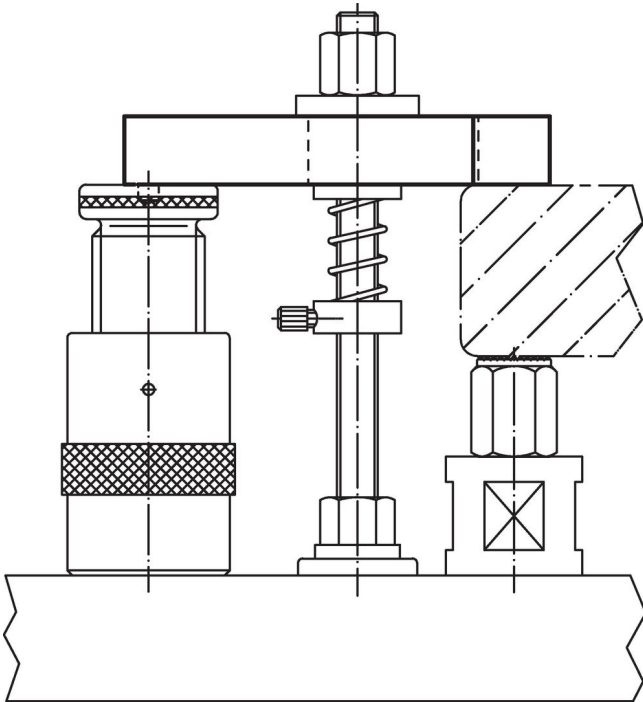

## Compliance

### RoHS compliant

Compliant according to Directive 2011/65/EU and Directive 2015/863.

### Does not contain SVHC substances

No SVHC substances with more than 0.1% w/w contained - SVHC list [REACH] as of 23.01.2024.

### Does not contain Proposition 65 substances

No Proposition 65 substances included.

<https://www.P65Warnings.ca.gov/>

### Free from Conflict Minerals

This product does not contain any substances designated as "conflict minerals" such as tantalum, tin, gold or tungsten from the Democratic Republic of Congo or adjacent countries.