

## Low Slot Tenons

EH 23130.



### Product Description

To be used for locating fixtures and clamping elements onto machine tables with T-slots to DIN 650.

### Material

- Steel, case-hardened, blackened, ground

### Assembly

They are bolted into the alignment slots of the fixture. Low slot tenons are suitable for use where a fixture will only be used on machines having an identical slot width.

### Drawing

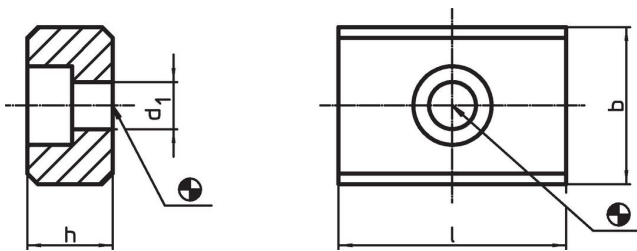

### Order information

b h6	h	Dimensions		d <sub>1</sub>	For screws ISO 4762 [mm]	[g]	Art. No.
		l	[mm]				
10	8	20		4.5	M4	11	<a href="#">23130.0010</a>
12	8	20		5.5	M5	11	<a href="#">23130.0012</a>
14	10	22		6.6	M6	18	<a href="#">23130.0014</a>
16	10	22		6.6	M6	22	<a href="#">23130.0016</a>
18	10	22		6.6	M6	25	<a href="#">23130.0018</a>
20	10	22		6.6	M6	29	<a href="#">23130.0020</a>
22	12	32		6.6	M6	60	<a href="#">23130.0022</a>
24	12	32		6.6	M6	65	<a href="#">23130.0024</a>

### Application example

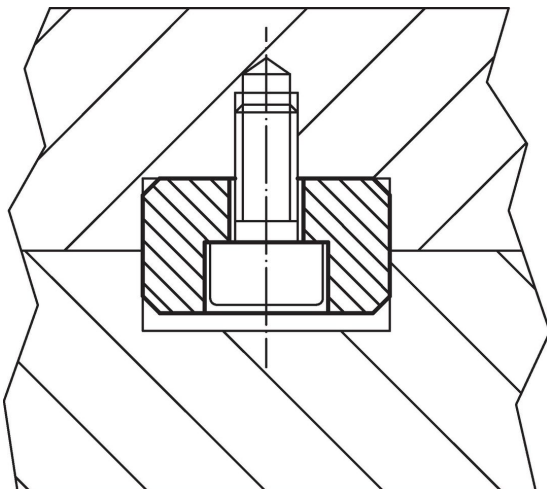

## Compliance

### RoHS compliant

Compliant according to Directive 2011/65/EU and Directive 2015/863.

### Does not contain SVHC substances

No SVHC substances with more than 0.1% w/w contained - SVHC list [REACH] as of 23.01.2024.

### Does not contain Proposition 65 substances

No Proposition 65 substances included.

<https://www.P65Warnings.ca.gov/>

### Free from Conflict Minerals

This product does not contain any substances designated as "conflict minerals" such as tantalum, tin, gold or tungsten from the Democratic Republic of Congo or adjacent countries.