

Fixed Slot Tenons · with cylindrical fastening

EH 23110.



Product Description

To be used for locating fixtures and clamping elements onto mounting pallets or pallets with cylindrical location holes. They can be inserted in holes as well as in slots.

Material

- Steel, case-hardened, blackened, ground

Drawing

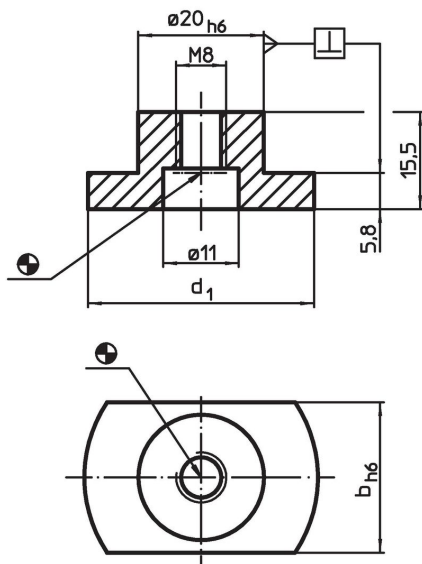

Order information

T-slot size machine b h6 [mm]	Dimensions d ₁ [mm]	For screws ISO 4762		[g]	Art. No.
		(picture 1)	(picture 2)		
10	30	M6	M8	28	23110.0110
12	30	M6	M8	30	23110.0112
14	30	M6	M8	33	23110.0114
16	30	M6	M8	36	23110.0116
18	30	M6	M8	45	23110.0118
20	36	M6	M8	45	23110.0120
22	40	M6	M8	54	23110.0122
28	42	M6	M8	65	23110.0128
36	48	M6	M8	86	23110.0136

Application example

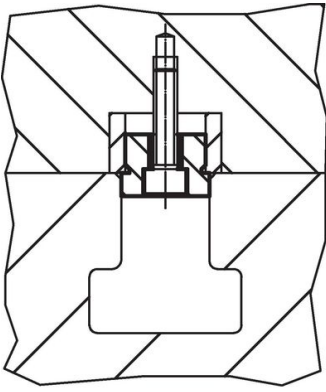

picture 1

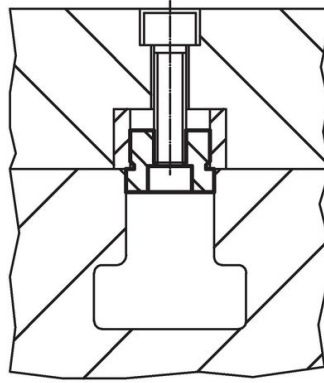

picture 2

Compliance

RoHS compliant

Compliant according to Directive 2011/65/EU and Directive 2015/863.

Does not contain SVHC substances

No SVHC substances with more than 0.1% w/w contained - SVHC list [REACH] as of 23.01.2024.

Does not contain Proposition 65 substances

No Proposition 65 substances included.

<https://www.P65Warnings.ca.gov/>

Free from Conflict Minerals

This product does not contain any substances designated as "conflict minerals" such as tantalum, tin, gold or tungsten from the Democratic Republic of Congo or adjacent countries.