

Washers · high precision design

EH 23060.



Product Description

The precisely manufactured washers have an allowance in parallelism of 0,05 mm.

Material

- Heat-treated steel, tempered, blackened
- Stainless steel 1.4305

Drawing

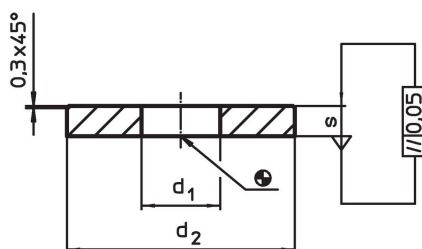

Order information

d ₁	Dimensions		s	For screws [mm]	[g]	Art. No.
	d ₂	[mm]				
Heat-treated steel						
5.3	13		3	M 5	2.5	23060.0105
6.4	17		3	M 6	4.6	23060.0106
8.4	24		4	M 8	12.0	23060.0108
10.5	30		4	M10	19.0	23060.0110
13.0	36		5	M12	34.0	23060.0113
17.0	45		5	M16	52.0	23060.0117
Stainless steel						
3.2	8		2	M 3	0.7	23060.0153
4.2	12		2	M 4	1.5	23060.0154
5.3	13		3	M 5	2.5	23060.0155
6.4	17		3	M 6	4.6	23060.0156
8.4	24		4	M 8	12.0	23060.0158
10.5	30		4	M10	19.0	23060.0160
13.0	36		5	M12	34.0	23060.0163
17.0	45		5	M16	52.0	23060.0167

Application example

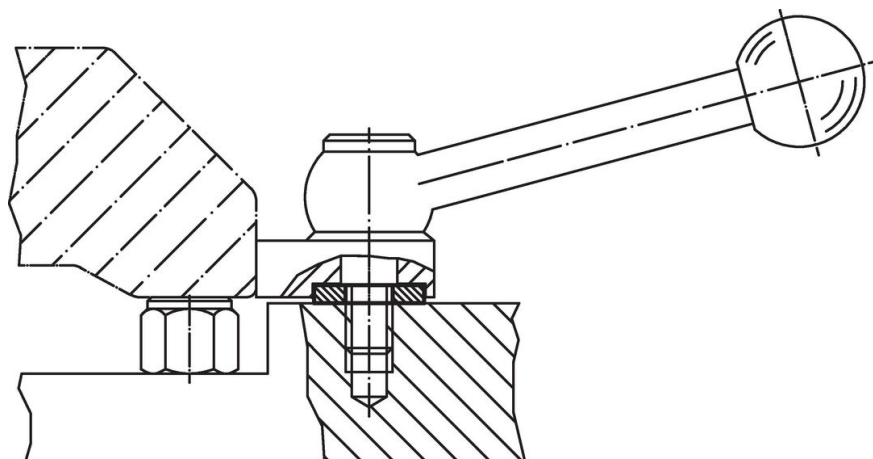

Compliance

RoHS compliant

Compliant according to Directive 2011/65/EU and Directive 2015/863.

Does not contain SVHC substances

No SVHC substances with more than 0.1% w/w contained - SVHC list [REACH] as of 23.01.2024.

Does not contain Proposition 65 substances

No Proposition 65 substances included.

<https://www.P65Warnings.ca.gov/>

Free from Conflict Minerals

This product does not contain any substances designated as "conflict minerals" such as tantalum, tin, gold or tungsten from the Democratic Republic of Congo or adjacent countries.