

Ball-Ended Thrust Screws • headed, ball protected against rotating

EH 22700.



Product Description

Ball-ended thrust screws can also be used for clamping, tightening or supporting of non-parallel surfaces.
The flat-faced, movable ball enables a flat load transmission.

Material

Ball

- Ball-bearing steel, hardened
- Stainless steel, hardened

Screw

- Heat-treated steel, $1200 \pm 100 \text{ N/mm}^2$
- Stainless steel 1.4305

More information

Notes

Note: Thread runout l_4 !
Ball protected against rotating.
Customized design on request.

References

Thread lock on request, please refer to appendix - Technical Data -

Further products

- Ball-Ended Thrust Screws, headed, flat-faced ball

Drawing



Order information

d ₁	l ₂	d ₂	Dimensions			Ball diameter	WS	Load capacity for static load ¹⁾ max.	[g]	Art. No.
			d ₃	l ₃	l ₄					
[mm]										
flat-faced ball, bearing surface plain, Heat-treated steel										
M 6	20	10	3.2	6	3.0	4.0	5	6	6.1	22700.0062
M 6	30	10	3.2	6	3.0	4.0	5	6	7.7	22700.0064
M 6	40	10	3.2	6	16.0	4.0	5	6	10.0	22700.0066
M 8	20	13	4.5	8	3.5	5.5	6	9	12.0	22700.0082
M 8	35	13	4.5	8	3.5	5.5	6	9	17.0	22700.0084
M 8	50	13	4.5	8	22.0	5.5	6	9	23.0	22700.0086
M10	25	16	6.0	10	4.5	7.0	8	12	24.0	22700.0102
M10	40	16	6.0	10	4.5	7.0	8	12	31.0	22700.0104
M10	60	16	6.0	10	28.0	7.0	8	12	44.0	22700.0106
M12	30	18	7.2	12	5.0	8.5	10	18	38.0	22700.0122
M12	50	18	7.2	12	5.0	8.5	10	18	52.0	22700.0124
M12	80	18	7.2	12	44.0	8.5	10	18	80.0	22700.0126
M16	40	24	10.7	16	6.0	12.0	14	36	93.0	22700.0162
M16	60	24	10.7	16	6.0	12.0	14	36	121.0	22700.0164
M16	80	24	10.7	16	36.0	12.0	14	36	153.0	22700.0166
M20	50	30	13.5	20	7.5	15.0	17	60	183.0	22700.0172
M20	80	30	13.5	20	28.0	15.0	17	60	254.0	22700.0174
M20	100	30	13.5	20	48.0	15.0	17	60	303.0	22700.0176
M24	60	36	15.8	24	9.0	18.0	19	80	325.0	22700.0182
M24	90	36	15.8	24	30.0	18.0	19	80	422.0	22700.0184
M24	120	36	15.8	24	60.0	18.0	19	80	528.0	22700.0186

¹⁾ Statements on load capacity are not valid for the stainless steel type.

d ₁	l ₂ ~	d ₂	Dimensions			Ball diameter	WS [mm]	Load capacity for static load ¹⁾ max. [kN]	[g]	Art. No.
			d ₃	l ₃	l ₄					
flat-faced ball, bearing surface plain, Stainless steel										
M 6	20	10	3.2	6	3.0	4.0	5	6	6.1	22700.0302
M 6	30	10	3.2	6	3.0	4.0	5	6	7.7	22700.0304
M 6	40	10	3.2	6	16.0	4.0	5	6	10.0	22700.0306
M 8	20	13	4.5	8	3.5	5.5	6	9	12.0	22700.0312
M 8	35	13	4.5	8	3.5	5.5	6	9	17.0	22700.0314
M 8	50	13	4.5	8	22.0	5.5	6	9	23.0	22700.0316
M10	25	16	6.0	10	4.5	7.0	8	12	24.0	22700.0322
M10	40	16	6.0	10	4.5	7.0	8	12	31.0	22700.0324
M10	60	16	6.0	10	28.0	7.0	8	12	44.0	22700.0326
M12	30	18	7.2	12	5.0	8.5	10	18	38.0	22700.0332
M12	50	18	7.2	12	5.0	8.5	10	18	52.0	22700.0334
M12	80	18	7.2	12	44.0	8.5	10	18	80.0	22700.0336
M16	40	24	10.7	16	6.0	12.0	14	36	93.0	22700.0342
M16	60	24	10.7	16	6.0	12.0	14	36	121.0	22700.0344
M16	80	24	10.7	16	36.0	12.0	14	36	153.0	22700.0346
flat-faced ball, bearing surface ribbed, Heat-treated steel										
M 8	20	13	4.5	8	3.5	5.5	6	9	12.0	22700.0192
M 8	35	13	4.5	8	3.5	5.5	6	9	17.0	22700.0194
M 8	50	13	4.5	8	22.0	5.5	6	9	23.0	22700.0196
M10	25	16	6.0	10	4.5	7.0	8	12	24.0	22700.0202
M10	40	16	6.0	10	4.5	7.0	8	12	31.0	22700.0204
M10	60	16	6.0	10	28.0	7.0	8	12	44.0	22700.0206
M12	30	18	7.2	12	5.0	8.5	10	18	38.0	22700.0222
M12	50	18	7.2	12	5.0	8.5	10	18	52.0	22700.0224
M12	80	18	7.2	12	44.0	8.5	10	18	80.0	22700.0226
M16	40	24	10.7	16	6.0	12.0	14	36	94.0	22700.0262
M16	60	24	10.7	16	6.0	12.0	14	36	121.0	22700.0264
M16	80	24	10.7	16	36.0	12.0	14	36	153.0	22700.0266
M20	50	30	13.5	20	7.5	15.0	17	60	185.0	22700.0272
M20	80	30	13.5	20	28.0	15.0	17	60	253.0	22700.0274
M20	100	30	13.5	20	48.0	15.0	17	60	303.0	22700.0276
M24	60	36	15.8	24	9.0	18.0	19	80	321.0	22700.0282
M24	90	36	15.8	24	30.0	18.0	19	80	422.0	22700.0284
M24	120	36	15.8	24	60.0	18.0	19	80	535.0	22700.0286

¹⁾ Statements on load capacity are not valid for the stainless steel type.

Application example

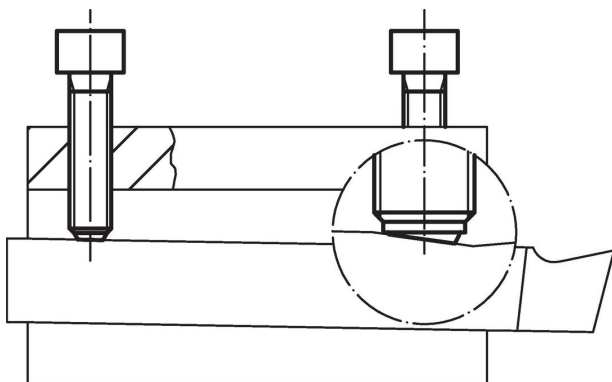

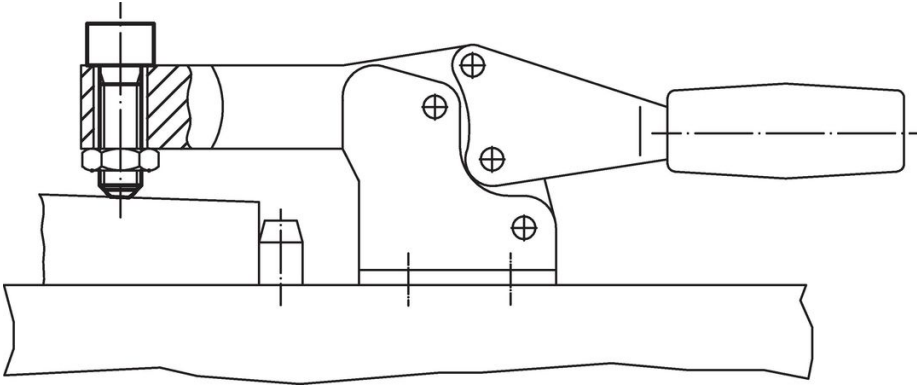

Compliance

RoHS compliant

Compliant according to Directive 2011/65/EU and Directive 2015/863.

Does not contain SVHC substances

No SVHC substances with more than 0.1% w/w contained - SVHC list [REACH] as of 27.06.2024.

Does not contain Proposition 65 substances

No Proposition 65 substances included.

<https://www.P65Warnings.ca.gov/>

Free from Conflict Minerals

This product does not contain any substances designated as "conflict minerals" such as tantalum, tin, gold or tungsten from the Democratic Republic of Congo or adjacent countries.