

Ball Lock Connectors • self-locking, with holder, compact construction

EH 22330.

**Product Description**

Parts can be connected fast and easily with the ball lock connector in combination with the locating bushings.

The locating bushings are made from stainless steel. There are three versions available - mounting in wood (picture 2 and picture 4), one version that can be mounted in plastic (picture 3) and with holding (picture 5 and picture 6). In the bushings (picture 2, picture 3 and picture 5) the ball lock connector is lockable (4x90°). In the bushings (picture 4 and picture 6) the ball lock connector is rotatable.

As a robust tool, the item is made from stainless steel. The ball lock connector is maintenance-free, soundless and secured against loss.

Material**Pin part**

- Stainless steel 1.4542

Holder

- Stainless steel

Bushing

- Stainless steel 1.4305

Ball

- Stainless steel

Spring

- Stainless steel

Assembly**Mounting into wood (picture 2 and picture 4)**

1. Insert location hole and pilot hole for safety bolt according to specifications
2. Optionally recommended is the use of adhesive for securing
3. Press in bushing
4. Secure bushing with a screw

Note: The bore diameter (D_2) for the pilot hole of the safety bolt depends on the screw used.

Mounting into plastic (picture 3)

1. Insert location hole according to instructions
2. Optionally recommended is the use of adhesive for securing
3. Screw in bushing

Note: The bore diameter to be chosen for the location hole depends on the hardness of the plastic.

Operation

The balls are unlocked by pressing the button.

More information**Notes**

Special types on request.

Further products

- Ball Lock Connectors, self-locking, with holding rings
- Ball Lock Connectors, self-locking, with holder

Drawing

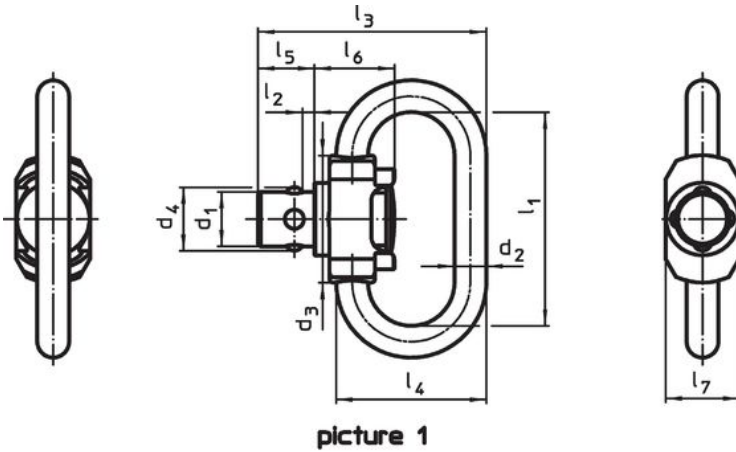

picture 1

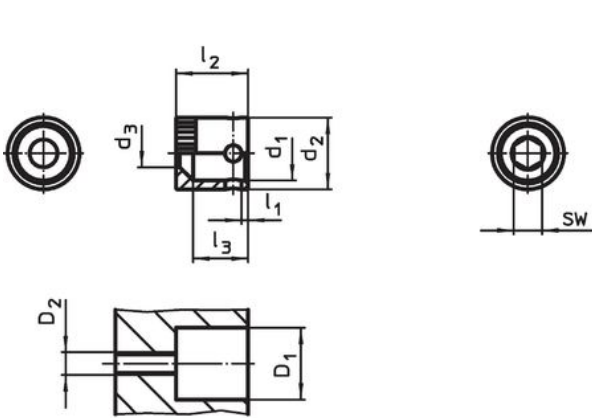

picture 2

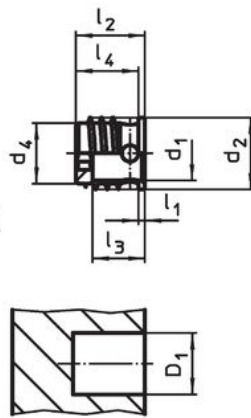

picture 3

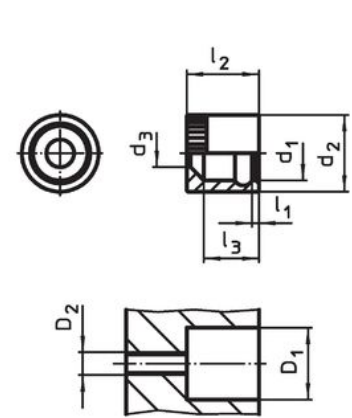

picture 4

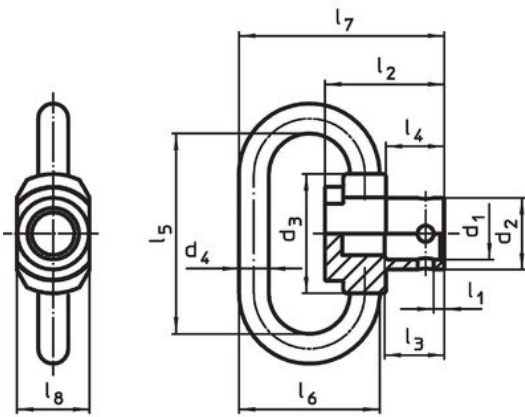

picture 5

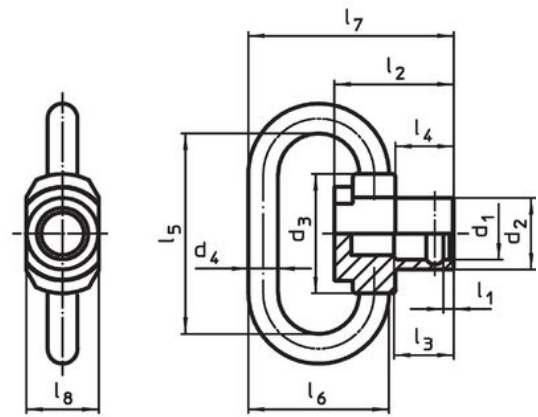

picture 6

Order information

Nominal diameter d ₁ [mm]	Dimensions												WS [mm]	Load capacity max. [kN]	Location hole D ₁ [mm]	Temperature		Weight [g]	Art. No.
	l ₁	l ₂	d ₂	d ₃	d ₄	l ₃	l ₄	l ₅	l ₆	l ₇	l ₈	min.				max.	[°C]		
Ball Lock Connectors – picture 1																			
6.0	23	1	3.50	14.0	6.9	25.1	16.5	6.2	8.8	8.1	–	–	1.5	–	-50	150	9.8	22330.0402	
bushing, mounting in wood, lockable – picture 2																			
6.1	1	9	8.15	3.1	–	7.0	–	–	–	–	–	–	–	8.3	-50	150	1.6	22330.0405	
bushing, mounting in plastic, lockable – picture 3																			
6.1	1	9	10.00	–	8.2	6.5	8.2	–	–	–	–	4	–	8.3 ¹⁾	-50	150	3.6	22330.0407	
bushing, mounting in wood, rotatable – picture 4																			
6.1	1	9	9.15	3.1	–	7.0	–	–	–	–	–	–	–	9.1	-50	150	2.4	22330.0409	
flexible mount, lockable – picture 5																			
6.1	1	14	8.40	14.0	3.5	7.0	6.8	23.0	16.5	24.1	8.5	–	1.5	–	-50	150	13.0	22330.1405	
flexible mount, rotatable – picture 6																			
6.1	1	14	8.40	14.0	3.5	7.0	6.8	23.0	16.5	24.1	8.5	–	1.5	–	-50	150	10.0	22330.1409	

¹⁾ depending on the hardness of the plastic

Application example

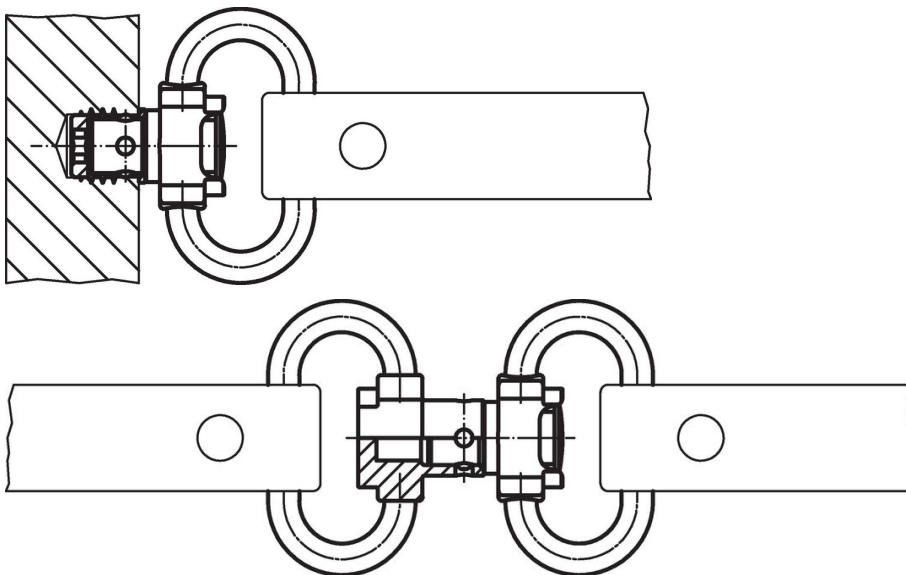

Compliance

RoHS compliant

Compliant according to Directive 2011/65/EU and Directive 2015/863.

Does not contain SVHC substances

No SVHC substances with more than 0.1% w/w contained - SVHC list [REACH] as of 23.01.2024.

Does not contain Proposition 65 substances

No Proposition 65 substances included.

<https://www.P65Warnings.ca.gov/>

Free from Conflict Minerals

This product does not contain any substances designated as "conflict minerals" such as tantalum, tin, gold or tungsten from the Democratic Republic of Congo or adjacent countries.