

Connecting Elements • modular, pneumatically operated, reinforced EH 1990.



Product Description

Material

- Body**
- Steel, case-hardened, ground

- Control module**
- Aluminium Al

More information

Further products

- Connecting Rings
- Coverings, for connecting elements

Drawing

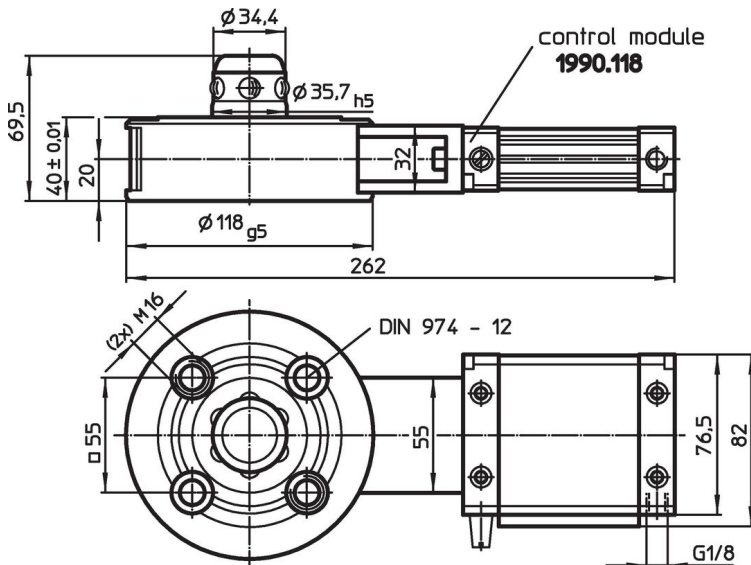

Order information

Holding force [N]	Centering accuracy < [mm]	Release pressure [bar]	[kg]	Art. No.
10000	0.01	6	4	1990.104

Application example

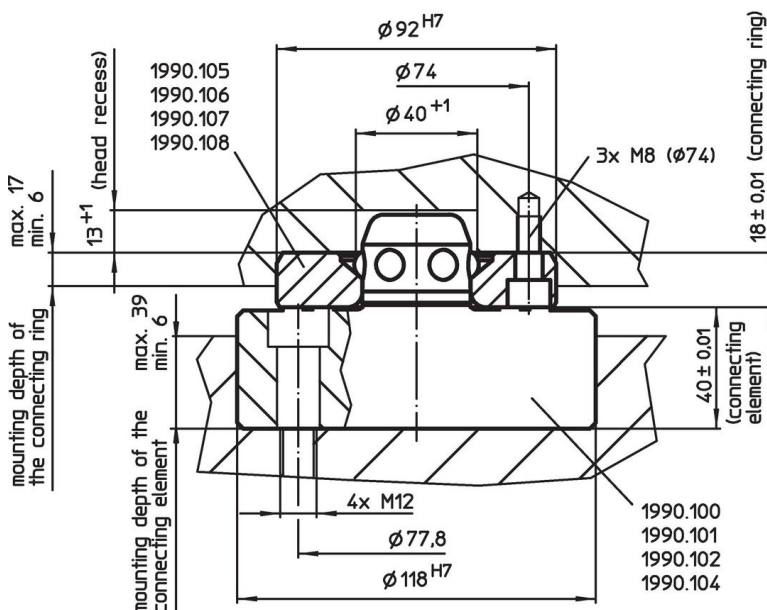

Compliance

Non-RoHS compliant

Not compliant according to Directive 2011/65/EU and Directive 2015/863.

Contains SVHC substances >0,1% w/w

Contains lead - SVHC list [REACH] as of 27.06.2024.

Contains Proposition 65 substances



Lead can cause cancer and reproductive harm from exposure
<https://www.P65Warnings.ca.gov/>

Free from Conflict Minerals

This product does not contain any substances designated as "conflict minerals" such as tantalum, tin, gold or tungsten from the Democratic Republic of Congo or adjacent countries.