

Base Plates · with positioning holes

EH 1912.



Product Description

Material

- Grey cast iron GG

More information

Notes

Special plates on request.

Drawing

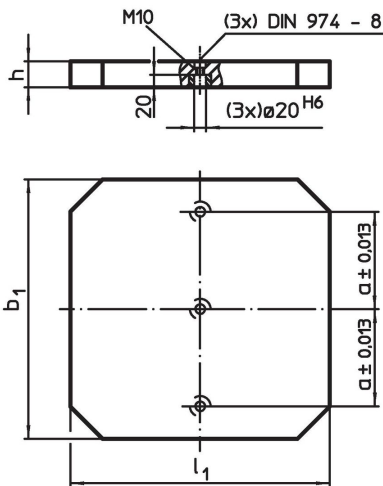

Order information

$b_1 \times l_1$	Dimensions			Art. No.
	h [mm]	a ± 0.013		
400 x 400	40±0.02	150	45	1912.220
400 x 500	40±0.02	150	57	1912.320
500 x 500	40±0.02	200	71	1912.420
500 x 630	50±0.03	200	112	1912.520
630 x 630	50±0.03	200	141	1912.620

Application example

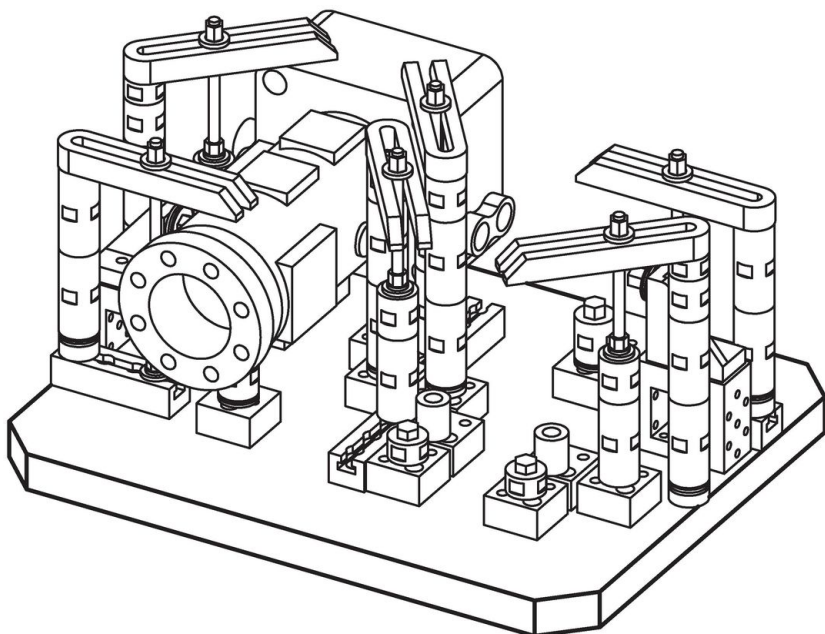

Compliance

RoHS compliant

Compliant according to Directive 2011/65/EU and Directive 2015/863.

Does not contain SVHC substances

No SVHC substances with more than 0.1% w/w contained - SVHC list [REACH] as of 23.01.2024.

Does not contain Proposition 65 substances

No Proposition 65 substances included.

<https://www.P65Warnings.ca.gov/>

Free from Conflict Minerals

This product does not contain any substances designated as "conflict minerals" such as tantalum, tin, gold or tungsten from the Democratic Republic of Congo or adjacent countries.