

Stops • vertical prisms
EH 1586.

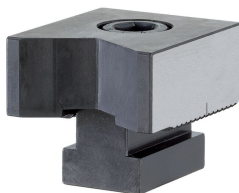

Product Description

Material

- Tool steel, hardened

Drawing

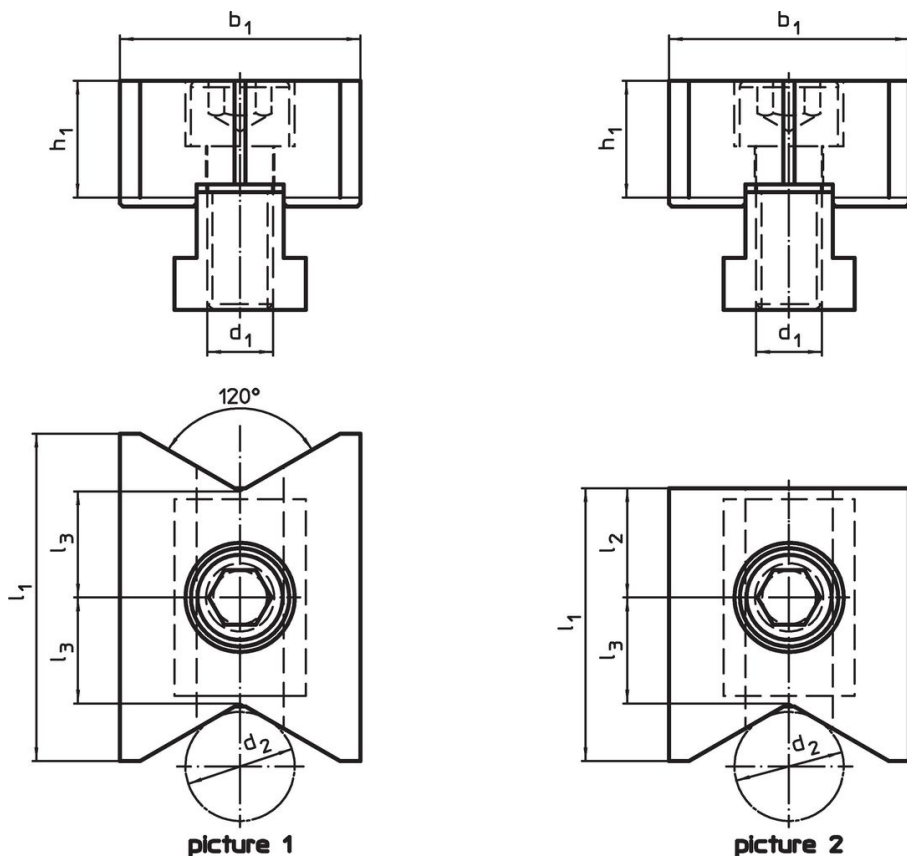

Order information

d ₁	d ₂	l ₁	Dimensions			b ₁ -0.05	h ₁	[g]	Art. No.
			l ₂ ±0.01	l ₃	[mm]				
vertical prisms on both sides – picture 1									
M12	10 – 70	60	–	19.4	44	21.4	485	1586.040	
vertical prism and plain – picture 2									
M12	10 – 70	50	20	19.4	44	21.4	444	1586.041	

Compliance

RoHS compliant

Compliant according to Directive 2011/65/EU and Directive 2015/863.

Does not contain SVHC substances

No SVHC substances with more than 0.1% w/w contained - SVHC list [REACH] as of 27.06.2024.

Does not contain Proposition 65 substances

No Proposition 65 substances included.

<https://www.P65Warnings.ca.gov/>

Free from Conflict Minerals

This product does not contain any substances designated as "conflict minerals" such as tantalum, tin, gold or tungsten from the Democratic Republic of Congo or adjacent countries.