

Locating Pins

EH 1140.300 - EH 1141.500



Product Description

Material

- Steel, case-hardened, ground

Drawing

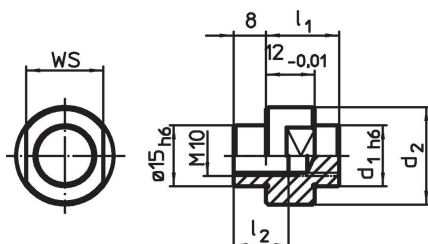

Order information

System	d ₁	d ₂	l ₁	Dimensions		WS	[g]	Art. No.
				[mm]	l ₂			
V70	4	19	16		13.5	15	28	1140.300
V70	5	19	16		13.5	15	29	1140.400
V70	6	19	16		13.5	15	30	1140.500
V70	8	19	17		13.5	15	28	1140.600
V70	10	19	17		13.5	15	31	1140.700
V70	12	19	18		13.5	15	33	1140.800
V70	14	24	18		13.5	19	51	1140.900
V70	15	24	18		[throughgoing thread]	19	49	1141.000
V70	16	24	18		[throughgoing thread]	19	48	1141.100
V70	18	29	19		[throughgoing thread]	22	70	1141.200
V70	20	29	19		[throughgoing thread]	22	72	1141.300
V70	22	34	20		[throughgoing thread]	27	101	1141.400
V70	24	34	20		[throughgoing thread]	27	105	1141.500

Application example

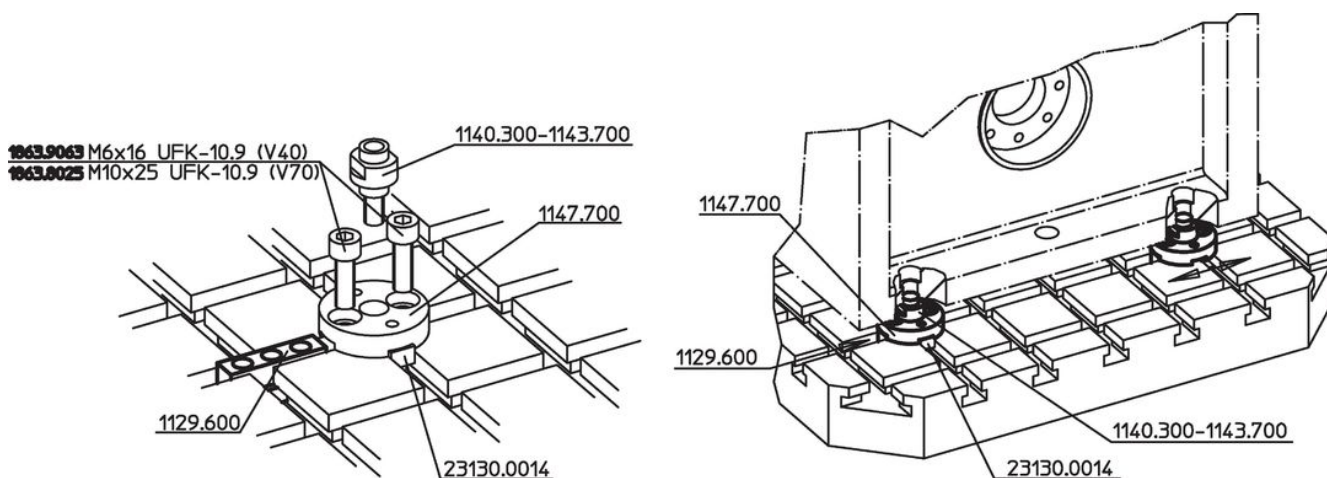

1063.9063 M6x16 UFK-10.9 (V40)
1063.6025 M10x25 UFK-10.9 (V70)



1863.9063 M6x16 UFK-10.9 (V40)
1863.8025 M10x25 UFK-10.9 (V70)

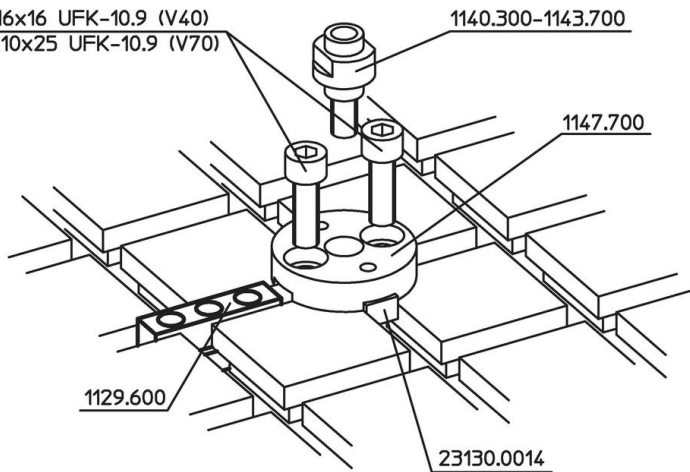

Compliance

RoHS compliant

Compliant according to Directive 2011/65/EU and Directive 2015/863.

Does not contain SVHC substances

No SVHC substances with more than 0.1% w/w contained - SVHC list [REACH] as of 27.06.2024.

Does not contain Proposition 65 substances

No Proposition 65 substances included.

<https://www.P65Warnings.ca.gov/>

Free from Conflict Minerals

This product does not contain any substances designated as "conflict minerals" such as tantalum, tin, gold or tungsten from the Democratic Republic of Congo or adjacent countries.