

Clamping Vices • fixed jaw

EH 1137.400



Product Description

Material

- Steel, case-hardened, ground

More information

Further products

- Clamping Vices
- Clamping Vices, moveable jaw
- Clamping Vices, replacement jaw, soft
- Clamping Vices, replacement jaw, ribbed/flat

Drawing

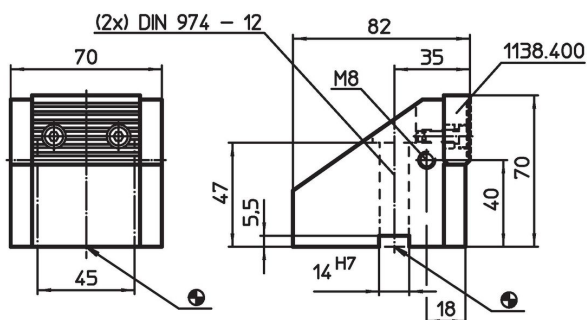

Order information

System	 [kg]	Art. No.
V70	2	1137.400

Compliance

RoHS compliant

Compliant according to Directive 2011/65/EU and Directive 2015/863.

Does not contain SVHC substances

No SVHC substances with more than 0.1% w/w contained - SVHC list [REACH] as of 23.01.2024.

Does not contain Proposition 65 substances

No Proposition 65 substances included.

<https://www.P65Warnings.ca.gov/>

Free from Conflict Minerals

This product does not contain any substances designated as "conflict minerals" such as tantalum, tin, gold or tungsten from the Democratic Republic of Congo or adjacent countries.