

## Base Plates

EH 1100.300 - EH 1100.500



### Product Description

#### Material

- Steel, hardened, ground

#### More information

#### Notes

Customized design on request.

### Drawing

#### 1100.300

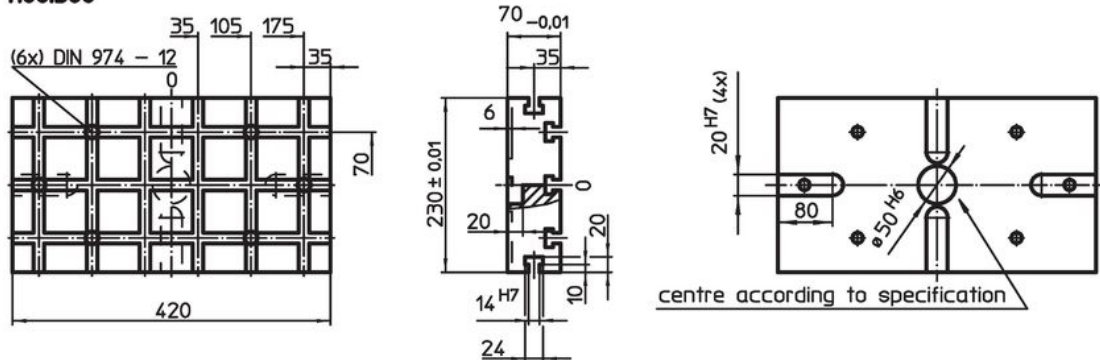

#### 1100.400

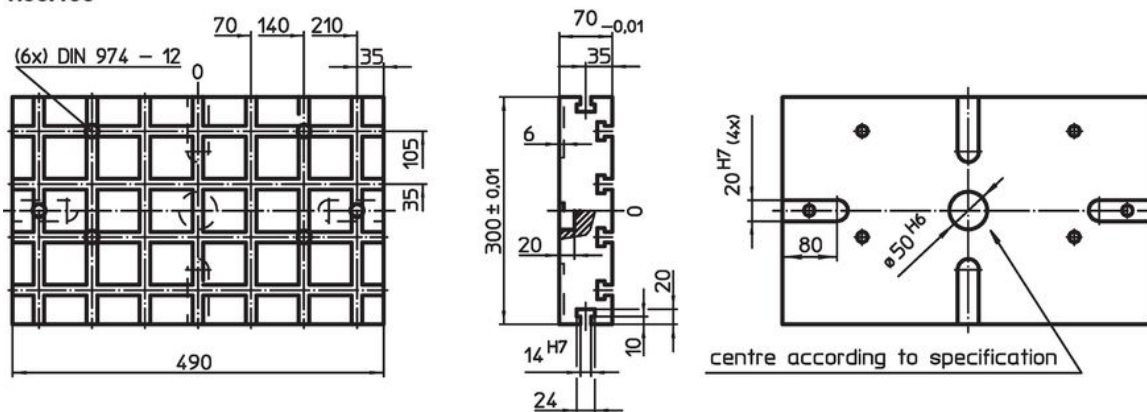

#### 1100.500

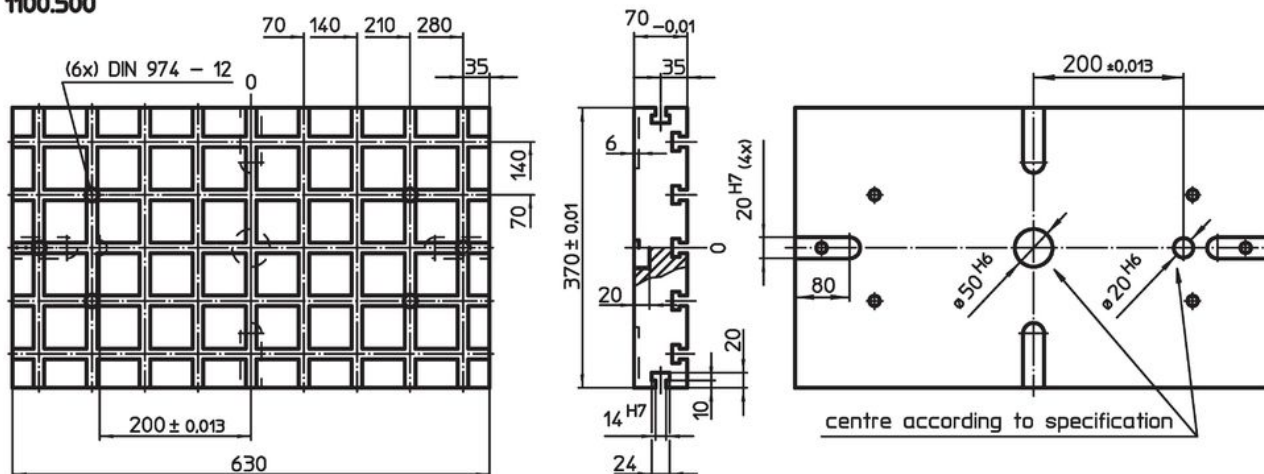

Slot spacing  $70 \pm 0,01$ .

Order information

System	Dimensions				y [mm]	Number of T-slots	 [kg]	Art. No.
	b <sub>1</sub>	b <sub>2</sub>	l <sub>1</sub>	l <sub>2</sub>				
V70	230	70	420	105	12	3 x 6	40	<a href="#">1100.300</a>
V70	300	140	490	140	12	4 x 7	65	<a href="#">1100.400</a>
V70	370	70	630	210	12	5 x 9	104	<a href="#">1100.500</a>

Application example

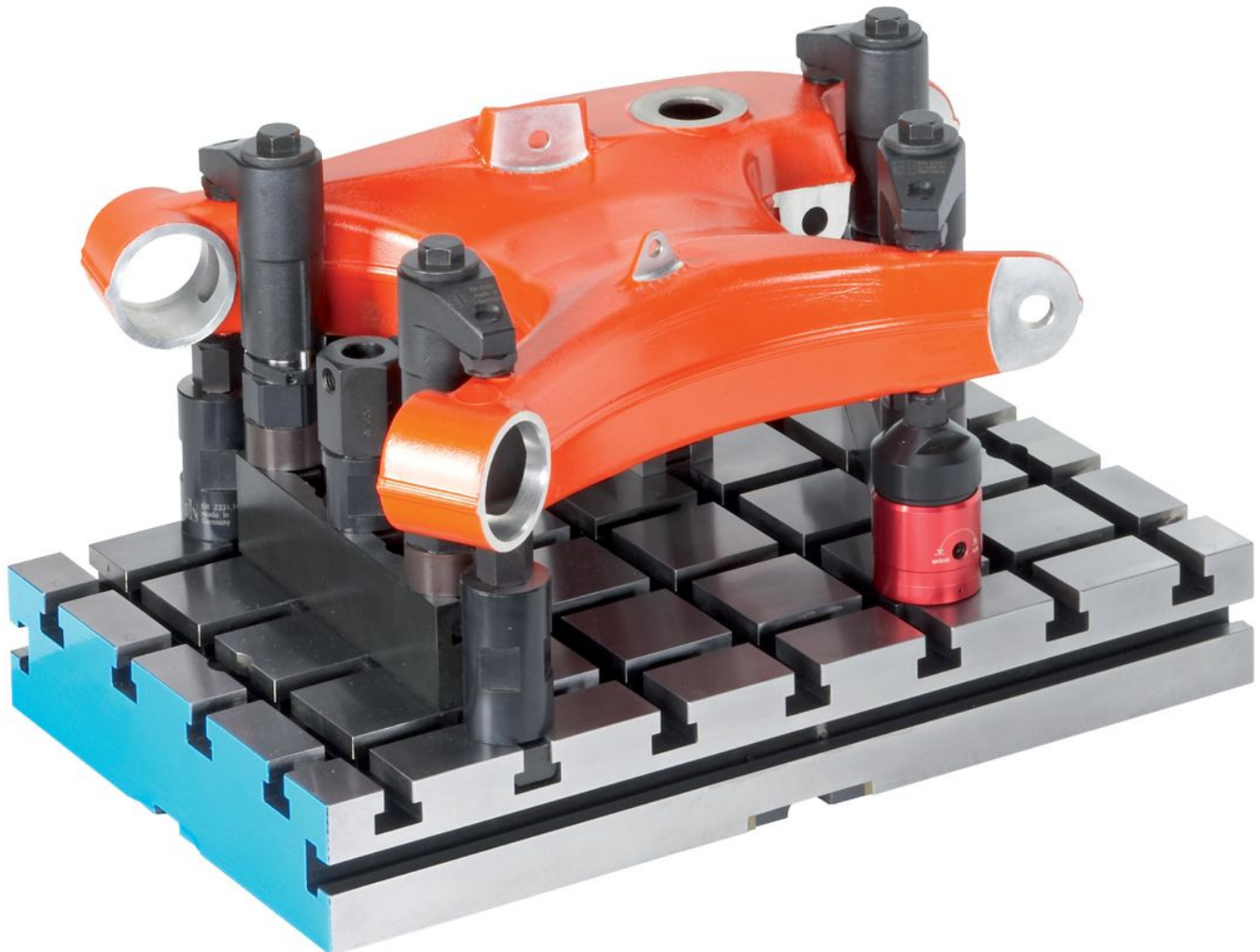

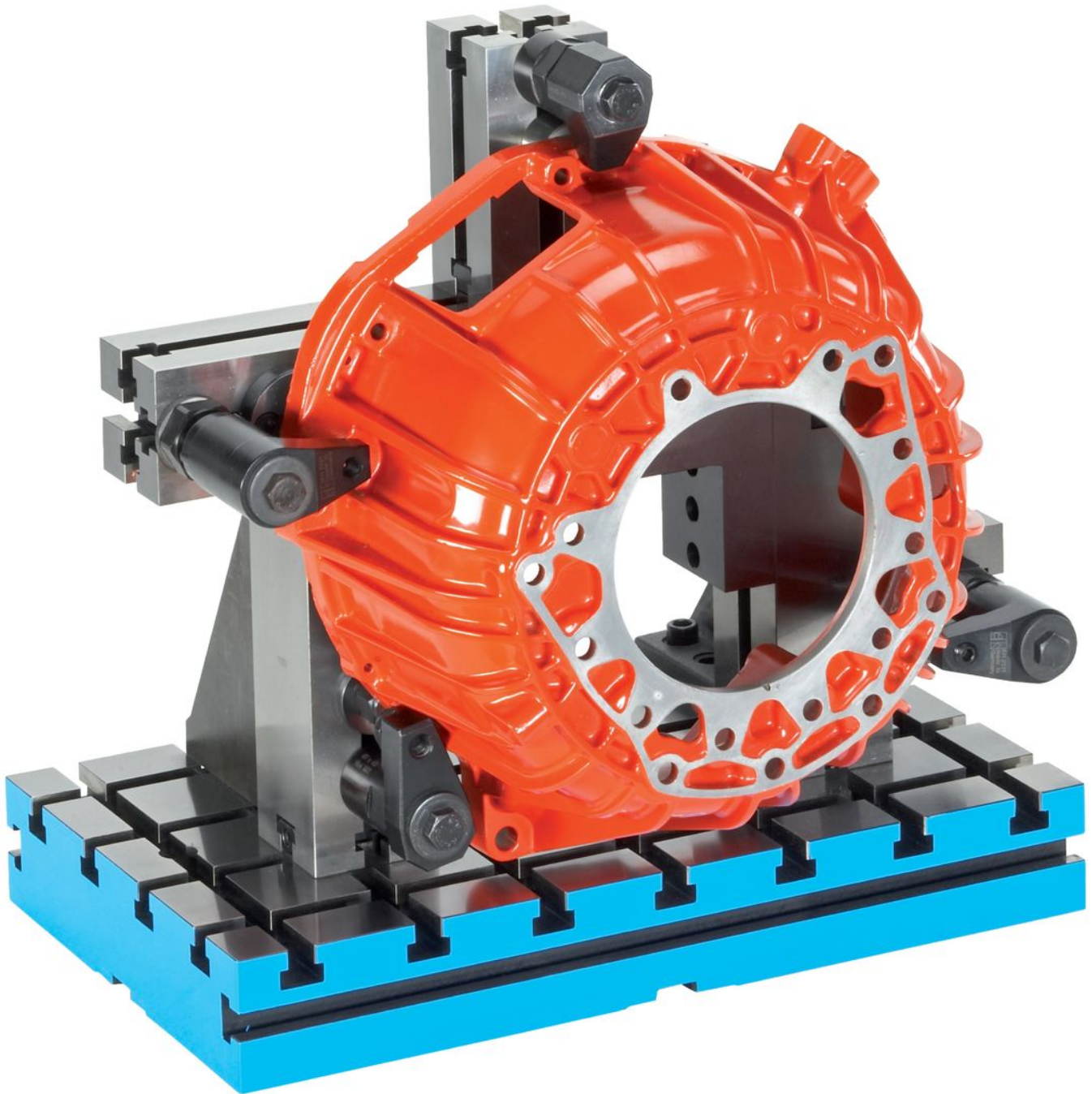

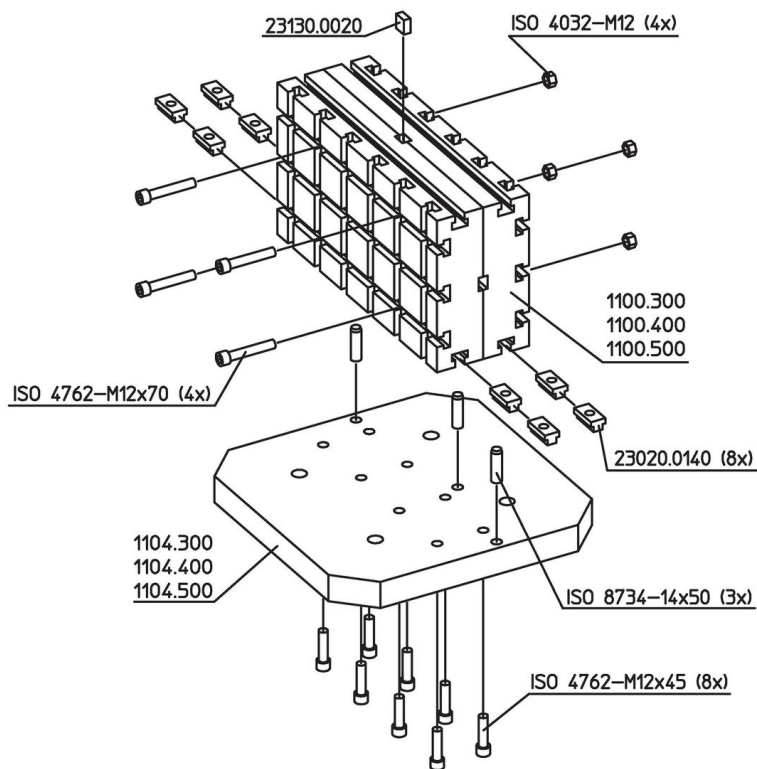

## Compliance

### RoHS compliant

Contains lead - compliant according to exceptions 6a / 6b / 6c.

### Contains SVHC substances >0,1% w/w

Contains lead - SVHC list [REACH] as of 27.06.2024.

### Contains Proposition 65 substances



Lead can cause cancer and reproductive harm from exposure  
<https://www.P65Warnings.ca.gov/>

### Free from Conflict Minerals

This product does not contain any substances designated as "conflict minerals" such as tantalum, tin, gold or tungsten from the Democratic Republic of Congo or adjacent countries.