

Hinges • stainless steel, elongated on both sides

25162.0110



Product Description

These hinges from stainless steel are characterised by the compact design. The hinge pins are form-fit pressed and are therefore suitable for use in case of strong vibrations and shocks. Appropriate friction pairings of the hinge components and the lubrication reduce abrasion to a minimum. The version with centering steps avoids lateral slipping under high loads and thus protects the fixing screws from unacceptable lateral forces.

Material

Body

- Stainless steel 1.4405, plastic-coated, black similar to RAL 9005, structure matt

Axis

- Stainless steel

Drawing

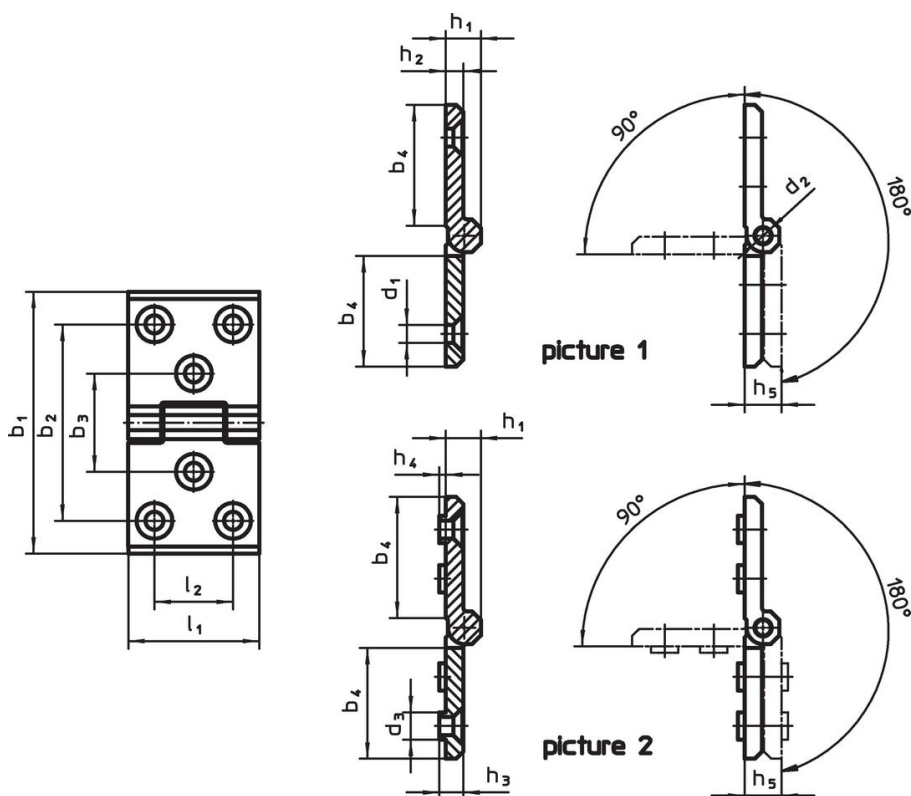

Order information

Dimensions														[g]	Art. No.
b ₁	l ₁	b ₂	b ₃	b ₄	d ₁	d ₂	d ₃	h ₁	h ₂	h ₃	h ₄	h ₅	l ₂		
with additional mounting hole and centring inserts on both sides – picture 2, black															
120	60	90	45	56	8.3	8	12.5	16	8	8.5	3	17	36	414	25162.0110

Compliance

RoHS compliant

Compliant according to Directive 2011/65/EU and Directive 2015/863.

Does not contain SVHC substances

No SVHC substances with more than 0.1% w/w contained - SVHC list [REACH] as of 27.06.2024.

Does not contain Proposition 65 substances

No Proposition 65 substances included.

<https://www.P65Warnings.ca.gov/>

Free from Conflict Minerals

This product does not contain any substances designated as "conflict minerals" such as tantalum, tin, gold or tungsten from the Democratic Republic of Congo or adjacent countries.