

## Rubber Endstop Buffers · cylindrical

25150.1353



### Product Description

To be used as an elastic end-stop, bearing foot etc.  
The hardness is  $55 \pm 5^\circ$  shore A. Further shore hardnesses ( $40 \pm 5^\circ$  shore A and  $70 \pm 5^\circ$  shore A) on request.

### Material

#### Support washer

- Stainless steel 1.4301

#### Threaded bushing

- Stainless steel 1.4301

#### Body

- Rubber natural caoutchouc (NR), black

### More information

#### Further products

- Support Legs, impact cushioning

### Drawing

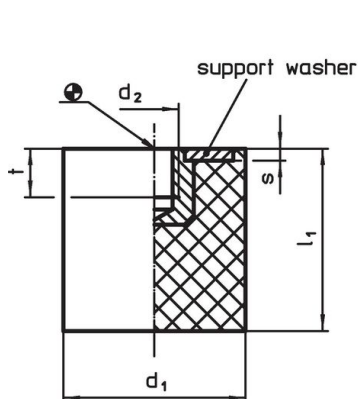

picture 1



picture 2

### Order information

Dimensions					Spring rate R ~ [N/mm]	Load capacity max. [N]	Spring range ~ [mm]	Temperature		Weight [g]	Art. No.
d <sub>1</sub>	l <sub>1</sub>	d <sub>2</sub>	s	t				min.	max.		
[mm]											
with female thread – picture 1, Stainless steel											
50	40	M10	2	7	247	2468	10	-30	80	120	25150.1353

### Application example



## Compliance

### RoHS compliant

Compliant according to Directive 2011/65/EU and Directive 2015/863.

### Does not contain SVHC substances

No SVHC substances with more than 0.1% w/w contained - SVHC list [REACH] as of 27.06.2024.

### Does not contain Proposition 65 substances

No Proposition 65 substances included.

<https://www.P65Warnings.ca.gov/>

### Free from Conflict Minerals

This product does not contain any substances designated as "conflict minerals" such as tantalum, tin, gold or tungsten from the Democratic Republic of Congo or adjacent countries.