

Rubber Endstop Buffers · truncated cone form

25150.0919



Product Description

To be used as an elastic end-stop, bearing foot etc.
The hardness is $55 \pm 5^\circ$ shore A. Further shore hardnesses ($40 \pm 5^\circ$ shore A and $70 \pm 5^\circ$ shore A) on request.

Material

Support washer

- Stainless steel 1.4301

Threaded bushing

- Stainless steel 1.4301

Body

- NBR

More information

Further products

- Support Legs, impact cushioning
- Silicone Endstop Buffers, truncated cone form

Drawing

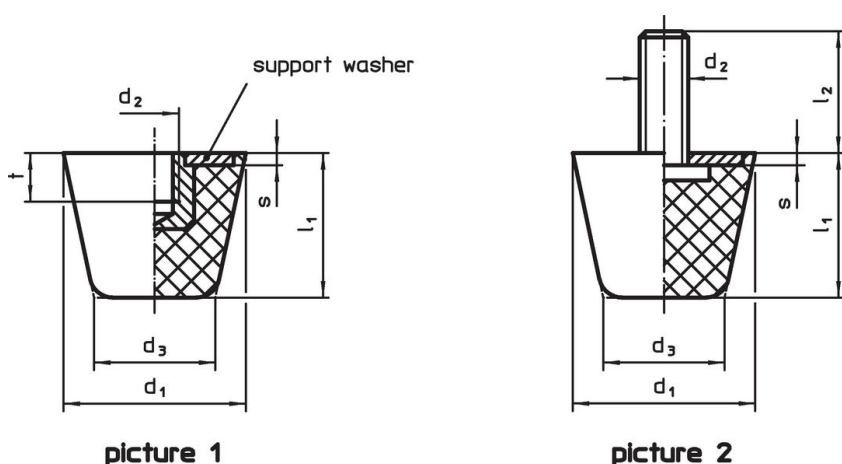

picture 1

picture 2

Order information

Dimensions						Spring rate R ~ [N/mm]	Load capacity max. [N]	Spring range ~ [mm]	Temperature		Weight [g]	Art. No.
d ₁	d ₂	d ₃	l ₁	s	t				min.	max.		
[mm]									[°C]			
with female thread – picture 1, Stainless steel												
19	M5	12	16	2	5	28	110	4	-30	80	7	25150.0919

Compliance

RoHS compliant

Compliant according to Directive 2011/65/EU and Directive 2015/863.

Does not contain SVHC substances

No SVHC substances with more than 0.1% w/w contained - SVHC list [REACH] as of 23.01.2024.

Does not contain Proposition 65 substances

No Proposition 65 substances included.

<https://www.P65Warnings.ca.gov/>

Free from Conflict Minerals

This product does not contain any substances designated as "conflict minerals" such as tantalum, tin, gold or tungsten from the Democratic Republic of Congo or adjacent countries.