

## Height-Adjusting Elements

25120.0046



### Product Description

For levelling of machines and installations.  
For vertical adjustment, the self-locking height-adjusting elements are fitted with a fine-pitch thread. All elements have a throughgoing bore for fastening purposes. A turn-out lock serves as height limit for the maximum adjustment height.

### Material

- Heat-treated steel, zinc-plated by galvanization, chromalized

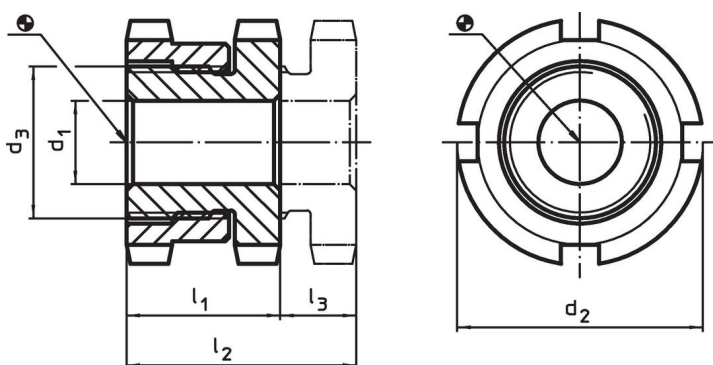

### Drawing



### Order information

d <sub>1</sub>	d <sub>2</sub>	Dimensions d <sub>3</sub> [mm]	l <sub>1</sub> ~	l <sub>2</sub> ~	Stroke l <sub>3</sub> ~ [mm]	For screw [mm]	Load capacity for static load max. [kN]	Load capacity max. [kN]	 [g]	Art. No.
33	70	M50 x 1,5	33	43	10	M30	330	53	640	25120.0046

### Accessories

	For height adjusting element size d <sub>2</sub> [mm]	Dimensions of sickle spanner DIN 1810, form A [mm]	 [g]	Art. No.
<b>sickle spanner for vertical adjustment</b>				
	70	68 – 75	253	25120.0985

Application example



Compliance

**RoHS compliant**

Compliant according to Directive 2011/65/EU and Directive 2015/863.

**Does not contain SVHC substances**

No SVHC substances with more than 0.1% w/w contained - SVHC list [REACH] as of 23.01.2024.

**Does not contain Proposition 65 substances**

No Proposition 65 substances included.

<https://www.P65Warnings.ca.gov/>

**Free from Conflict Minerals**

This product does not contain any substances designated as "conflict minerals" such as tantalum, tin, gold or tungsten from the Democratic Republic of Congo or adjacent countries.