

Sensing Elements · with sensor adapter

25010.0016

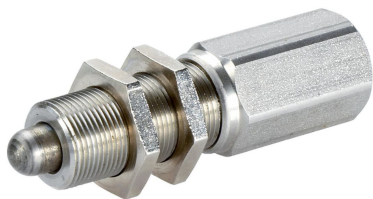

Product Description

Spring plunger in robust and compact design with fine-pitch thread and integrated position sensing using standard proximity sensors. Suitable for multiple applications, e.g. for locking including position control and for proximity sensors with **flush contact**. Switching range adjustable via screwed position of sensor. Sensitivity of switching operations can be adjusted throughout the entire stroke.

Material

Pin

- Stainless steel 1.4305

Housing

- Stainless steel 1.4305

Nut

- Brass (ISO 4035), nickel-plated

Spring

- Stainless steel

More information

Further products

- Retrieval Units, with sensor

Drawing

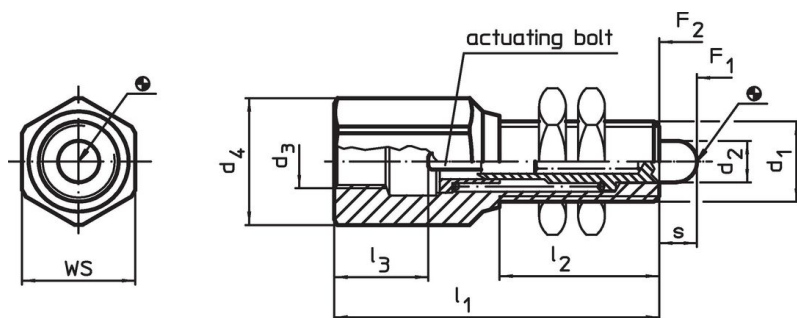

Order information

Dimensions								WS	Spring load ¹⁾		Art. No.	
d ₁	d ₂	d ₃	d ₄	l ₁	l ₂	l ₃	s		F ₁	F ₂		
[mm]								[mm]	[N]	[g]		
M16 x 1	8.5	M12 x 1	21.5	65	32	20	7.5	19	32.5	65.5	102	25010.0016

¹⁾ statistical average value

Application example



Compliance

RoHS compliant

Contains lead - compliant according to exceptions 6a / 6b / 6c.

Contains SVHC substances >0,1% w/w

Contains lead - SVHC list [REACH] as of 27.06.2024.

Contains Proposition 65 substances



Lead can cause cancer and reproductive harm from exposure
<https://www.P65Warnings.ca.gov/>

Free from Conflict Minerals

This product does not contain any substances designated as "conflict minerals" such as tantalum, tin, gold or tungsten from the Democratic Republic of Congo or adjacent countries.