

## Knurled Thumb Screws • plastic

24830.0074



### Product Description

#### Material

##### Handle

- Thermoplastic PA, black

##### Screw

- Steel, zinc-plated by galvanization

### Drawing

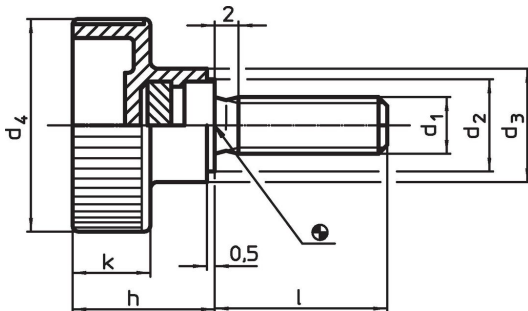

### Order information

Dimensions							Temperature		Weight	Art. No.
d <sub>1</sub>	l	d <sub>2</sub>	d <sub>3</sub>	d <sub>4</sub>	h	k	min.	max.	[g]	
[mm]							[°C]			
Steel										
M10	30	16	18	36	22.5	12.5	-30	80	33	24830.0074

### Application example

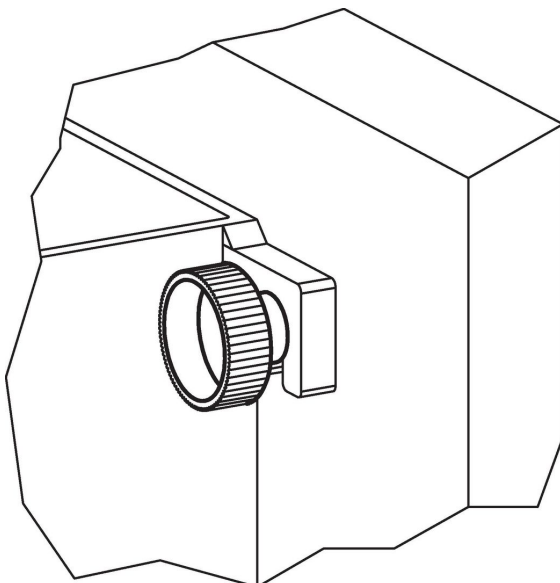

## Compliance

### RoHS compliant

Contains lead - compliant according to exceptions 6a / 6b / 6c.

### Contains SVHC substances >0,1% w/w

Contains lead - SVHC list [REACH] as of 23.01.2024.

### Contains Proposition 65 substances



Lead can cause cancer and reproductive harm from exposure  
<https://www.P65Warnings.ca.gov/>

### Free from Conflict Minerals

This product does not contain any substances designated as "conflict minerals" such as tantalum, tin, gold or tungsten from the Democratic Republic of Congo or adjacent countries.