

Knurled Nuts • plastic

24820.0006



Product Description

Material

Bushing

- Steel, zinc-plated by galvanization

Handle

- Thermoplastic PA, black

Drawing

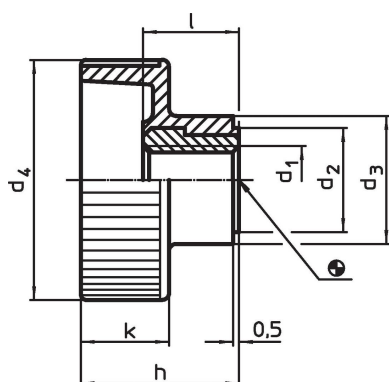

Order information

Dimensions								Temperature		Weight	Art. No.
d ₁	d ₂	d ₃	d ₄	h	k	l	min.	max.	[g]		
[mm]							[°C]				
Steel											
M6	12	14	24	16.5	9.5	10.5	-30	80	7	24820.0006	

Application example

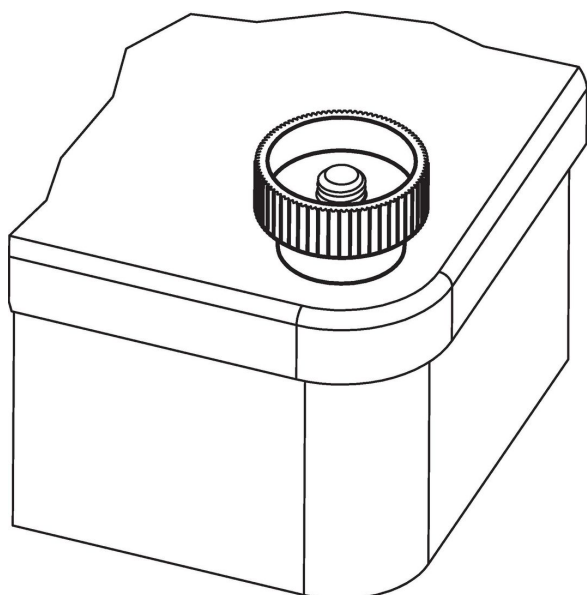

Compliance

RoHS compliant

Contains lead - compliant according to exceptions 6a / 6b / 6c.

Contains SVHC substances >0,1% w/w

Contains lead - SVHC list [REACH] as of 27.06.2024.

Contains Proposition 65 substances



Lead can cause cancer and reproductive harm from exposure
<https://www.P65Warnings.ca.gov/>

Free from Conflict Minerals

This product does not contain any substances designated as "conflict minerals" such as tantalum, tin, gold or tungsten from the Democratic Republic of Congo or adjacent countries.