

## High Knurled Thumb Screws • DIN 464

24790.0162



### Product Description

Knurled screws are one-piece manufactured. Contrary to the Standard Sheet, they are generally manufactured with a thread up to the head and with runout without undercut at the end of the thread. The screws can therefore not be screwed in up to the collar.

### Material

- Steel, blackened, quality 5.8

### More information

### Notes

Knurling pitch and knurling depth may differ from DIN.

### Drawing

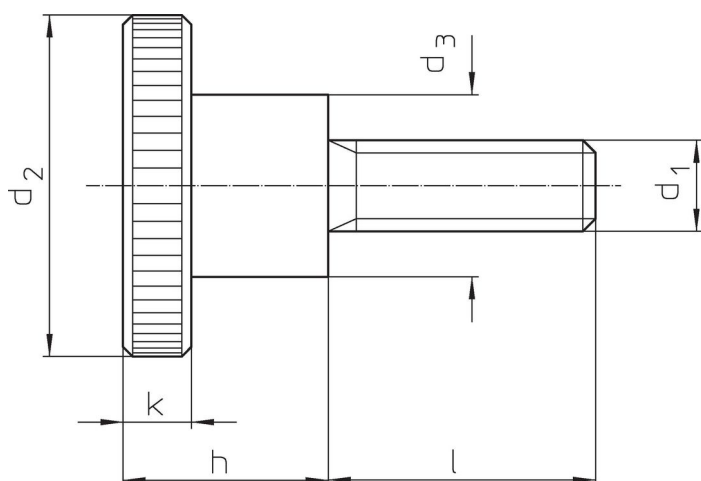

### Order information

Dimensions							Art. No.
$d_1$	$l$	$d_2$	$d_3$	$h$	$k$	[g]	
Steel							
M8	35	30	16	18	6	62	24790.0162

### Application example

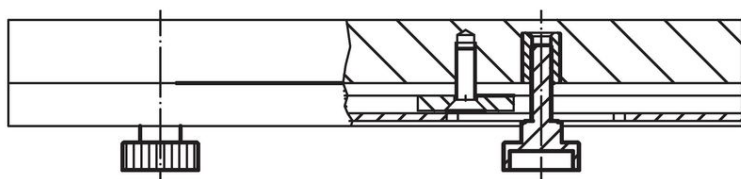
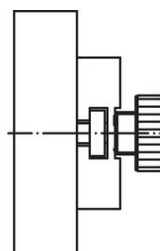
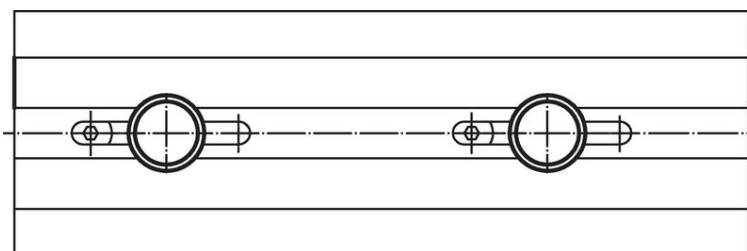

## Compliance

### RoHS compliant

Contains lead - compliant according to exceptions 6a / 6b / 6c.

### Contains SVHC substances >0,1% w/w

Contains lead - SVHC list [REACH] as of 23.01.2024.

### Contains Proposition 65 substances



Lead can cause cancer and reproductive harm from exposure  
<https://www.P65Warnings.ca.gov/>

### Free from Conflict Minerals

This product does not contain any substances designated as "conflict minerals" such as tantalum, tin, gold or tungsten from the Democratic Republic of Congo or adjacent countries.