

High Knurled Nuts • DIN 466

24780.0330



Product Description

Knurled nuts are very versatile. Three material versions for the different requirements

- Steel, blackened
- Steel, zinc-plated by galvanization
- Stainless steel

are available.

Knurled nuts can be easily tightened and released by hand. The ribbed outer surface of the nut prevents slipping when tightening / releasing with the fingers.

The high knurled nuts are manufactured according to DIN 467.

Material

- Steel, zinc-plated by galvanization, quality 5

More information

Notes

Knurling pitch and knurling depth may differ from DIN.

Further products

- Flat Knurled Nuts, DIN 467

Drawing

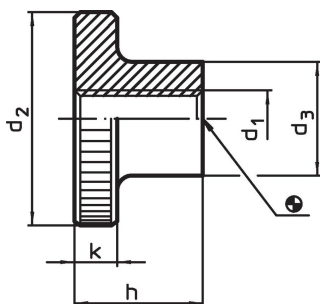

Order information

Dimensions						Art. No.
d ₁	d ₂	d ₃	h	k	[g]	
Steel						
M3	12	6	7.5	2.5	3	24780.0330

Application example

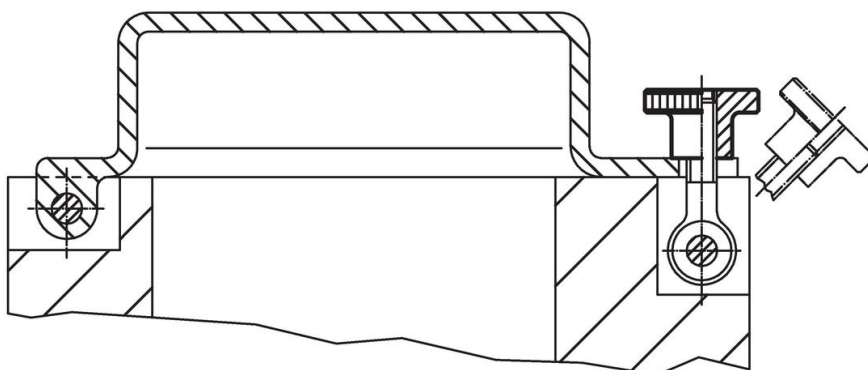

Compliance

RoHS compliant

Compliant according to Directive 2011/65/EU and Directive 2015/863.

Does not contain SVHC substances

No SVHC substances with more than 0.1% w/w contained - SVHC list [REACH] as of 27.06.2024.

Does not contain Proposition 65 substances

No Proposition 65 substances included.

<https://www.P65Warnings.ca.gov/>

Free from Conflict Minerals

This product does not contain any substances designated as "conflict minerals" such as tantalum, tin, gold or tungsten from the Democratic Republic of Congo or adjacent countries.