

Star Grip Screws • similar to DIN 6336, stainless steel

24741.0040



Product Description

These star grip screws are manufactured according to DIN 6336, but it is a version without dirty edges. This makes these star grip screws suitable for all areas of application with high hygienic requirements.

Material

Handle

- Stainless steel 1.4308, precision casting, matt blasted

Screw

- Stainless steel 1.4305

Drawing

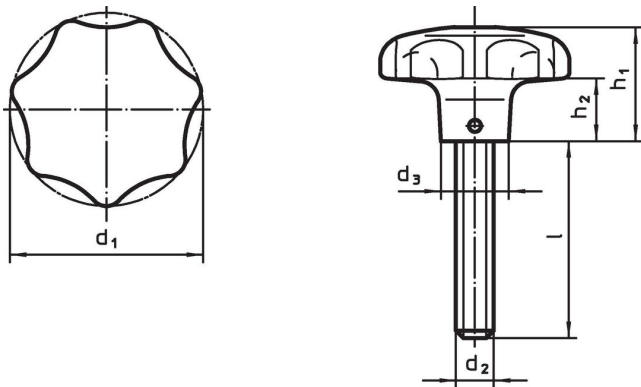

Order information

d ₁	d ₂	Dimensions				[g]	Art. No.
		l	d ₃	h ₁	h ₂		
50	M10	45	18	32	15	187	24741.0040

Compliance

RoHS compliant

Compliant according to Directive 2011/65/EU and Directive 2015/863.

Does not contain SVHC substances

No SVHC substances with more than 0.1% w/w contained - SVHC list [REACH] as of 27.06.2024.

Does not contain Proposition 65 substances

No Proposition 65 substances included.

<https://www.P65Warnings.ca.gov/>

Free from Conflict Minerals

This product does not contain any substances designated as "conflict minerals" such as tantalum, tin, gold or tungsten from the Democratic Republic of Congo or adjacent countries.