

Palm Grips • similar to DIN 6335, stainless steel A4
24631.1450



Product Description

Version without dirt trap. Convenient for all applications having high hygienic requirements (e.g. food industry).
The stainless steel A4 version ensures maximum corrosion resistance.

Material

Handle

- Stainless steel A4, polished

Drawing

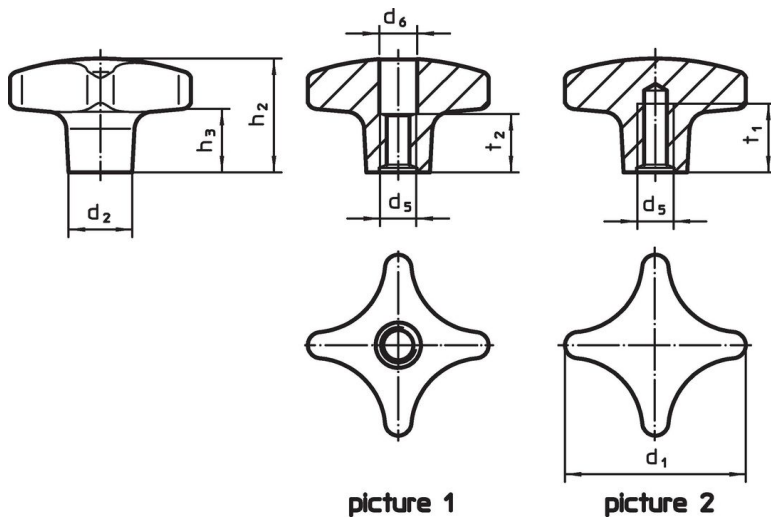

Order information

Dimensions						[g]	Art. No.
d ₁	d ₂	d ₅	h ₂	h ₃	t ₁ min.		
[mm]							
with threaded blind hole – picture 2							
50	18	M10	32	18	18	117	24631.1450

Compliance

RoHS compliant

Compliant according to Directive 2011/65/EU and Directive 2015/863.

Does not contain SVHC substances

No SVHC substances with more than 0.1% w/w contained - SVHC list [REACH] as of 23.01.2024.

Does not contain Proposition 65 substances

No Proposition 65 substances included.
<https://www.P65Warnings.ca.gov/>

Free from Conflict Minerals

This product does not contain any substances designated as "conflict minerals" such as tantalum, tin, gold or tungsten from the Democratic Republic of Congo or adjacent countries.