

**Palm Grips • DIN 6335 light metal**  
24630.0650



**Product Description**

These palm grips are manufactured according to DIN 6335.

**Material**

**Handle**

- Light metal Al, polished

**Drawing**

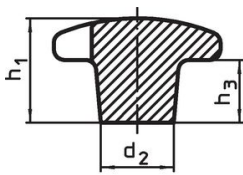

picture 1

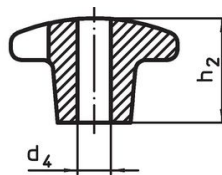

picture 2

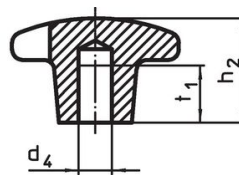

picture 3

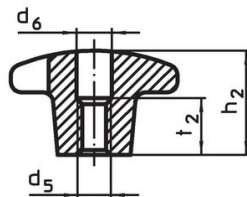
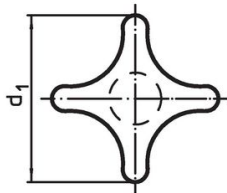

picture 4

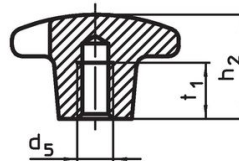

picture 5

**Order information**

Dimensions					[g]	Art. No.
d <sub>1</sub>	d <sub>2</sub>	d <sub>4</sub> H7 [mm]	h <sub>2</sub>	t <sub>1</sub>		
with smooth blind hole, form C – picture 3, polished						
50	18	10	32	18	42	24630.0650

## Application example

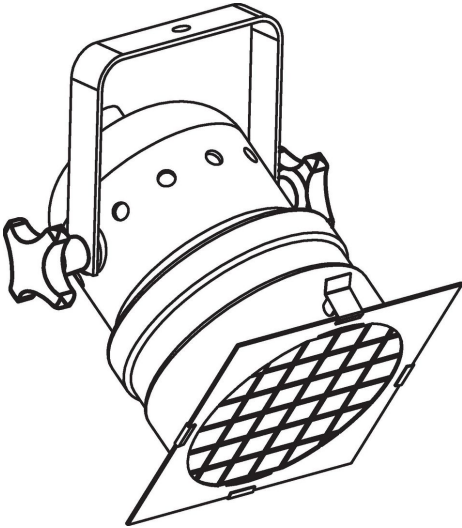

## Compliance

### RoHS compliant

Contains lead - compliant according to exceptions 6a / 6b / 6c.

### Contains SVHC substances >0,1% w/w

Contains lead - SVHC list [REACH] as of 23.01.2024.

### Contains Proposition 65 substances



Lead can cause cancer and reproductive harm from exposure  
<https://www.P65Warnings.ca.gov/>

### Free from Conflict Minerals

This product does not contain any substances designated as "conflict minerals" such as tantalum, tin, gold or tungsten from the Democratic Republic of Congo or adjacent countries.