

Handwheels • DIN 950 grey cast iron

24580.0130



Product Description

Hub machined; rim turned and mirror-finished on all sides, non-machined surfaces cleanly blasted.

Material

Handwheel
• Grey cast iron GG

Assembly

Shaft-end washers EH 22270. for axial fastening.

More information

Further products

- Shaft-End Washers
- Rotating Machine Handles, DIN 98

Drawing

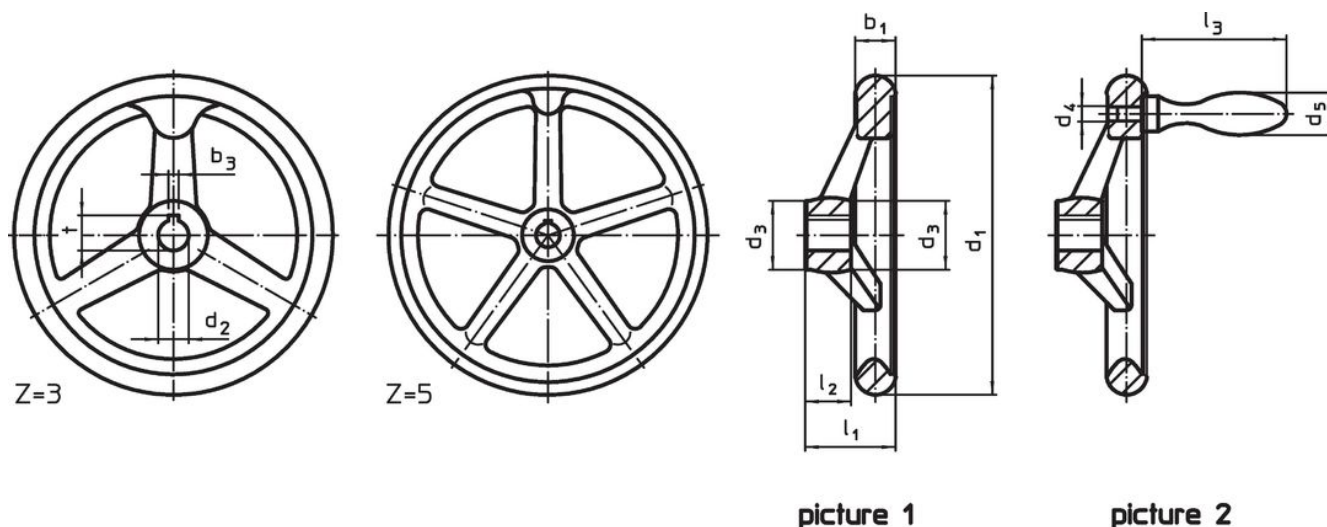

The orientation of the hub keyway may be different than shown in the drawing.

Order information

d ₁	Dimensions				Hub keyway, DIN 6885 sheet 1		Number of spokes z	[g]	Art. No.
	d ₂ H7	d ₃	l ₁ ~	l ₂	b ₃	t			
[mm]						[mm]			
with hub keyway, without handle, form N-F/A (formerly: A 3) – picture 1									
200	18	38	45	24	6	20.8	3	2142	24580.0130

Application example



Compliance

RoHS compliant

Compliant according to Directive 2011/65/EU and Directive 2015/863.

Does not contain SVHC substances

No SVHC substances with more than 0.1% w/w contained - SVHC list [REACH] as of 23.01.2024.

Does not contain Proposition 65 substances

No Proposition 65 substances included.

<https://www.P65Warnings.ca.gov/>

Free from Conflict Minerals

This product does not contain any substances designated as "conflict minerals" such as tantalum, tin, gold or tungsten from the Democratic Republic of Congo or adjacent countries.