

Conical Knobs

24550.0021



Product Description



Material

- Thermosetting plastic PF 31, black

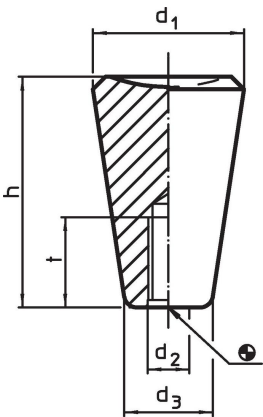
Drawing



Order information

Dimensions					 max. [°C]	 [g]	Art. No.
d ₁	d ₂	d ₃ ~ [mm]	h	t min.			
25	M8	15	38	18	110	17	24550.0021

Application example

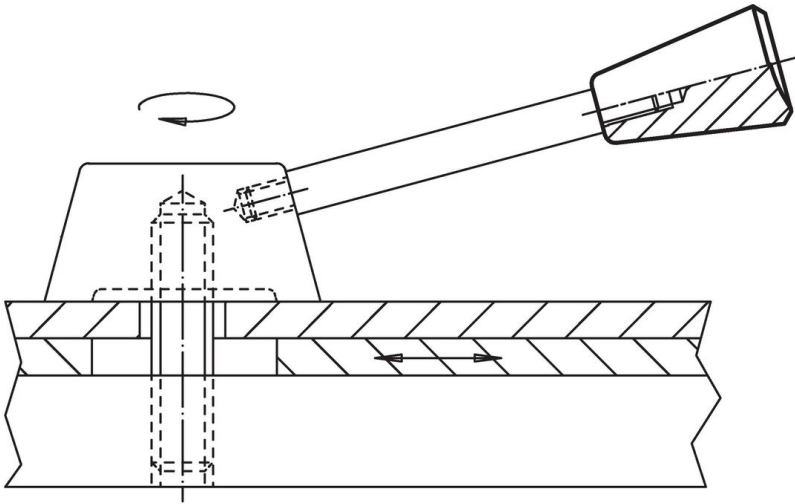

Compliance

RoHS compliant

Compliant according to Directive 2011/65/EU and Directive 2015/863.

Does not contain SVHC substances

No SVHC substances with more than 0.1% w/w contained - SVHC list [REACH] as of 27.06.2024.

Does not contain Proposition 65 substances

No Proposition 65 substances included.

<https://www.P65Warnings.ca.gov/>

Free from Conflict Minerals

This product does not contain any substances designated as "conflict minerals" such as tantalum, tin, gold or tungsten from the Democratic Republic of Congo or adjacent countries.