

## Clamping Nuts • welded, double-sided

24470.0716



### Product Description

Allows for two-handed operating.

### Material

- Steel, zinc-plated by galvanization

### Drawing

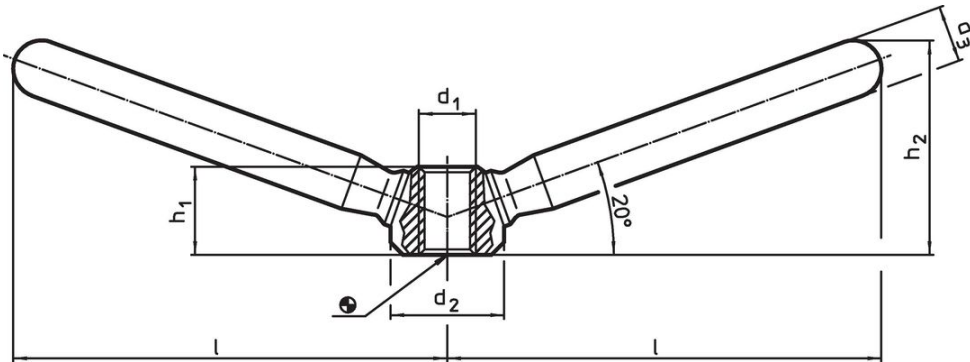

### Order information

l	d <sub>1</sub>	Dimensions			h <sub>1</sub>	h <sub>2</sub>	[g]	Art. No.
		d <sub>2</sub>	d <sub>3</sub>	[mm]				
Steel								
118	M20	40	20	31	62	716	24470.0716	

### Application example

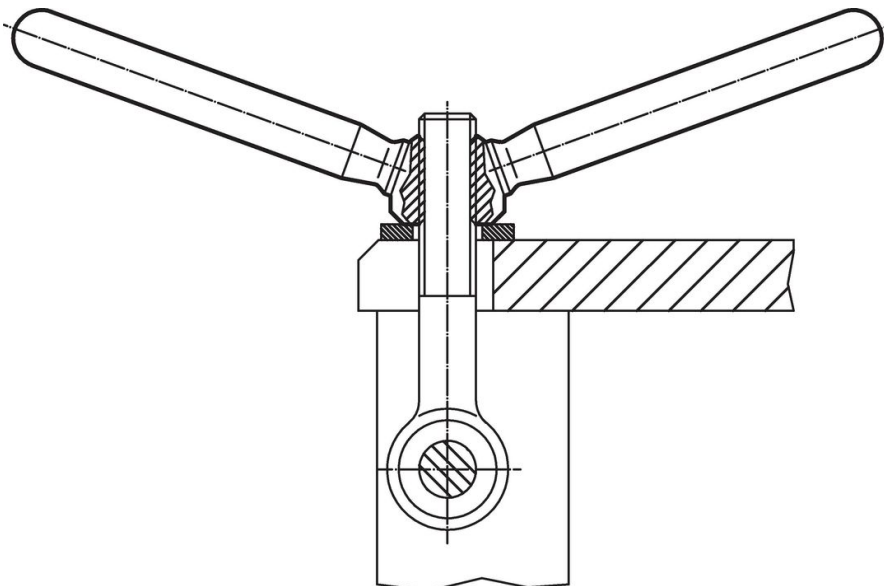

## Compliance

### RoHS compliant

Contains lead - compliant according to exceptions 6a / 6b / 6c.

### Contains SVHC substances >0,1% w/w

Contains lead - SVHC list [REACH] as of 27.06.2024.

### Contains Proposition 65 substances



Lead can cause cancer and reproductive harm from exposure  
<https://www.P65Warnings.ca.gov/>

### Free from Conflict Minerals

This product does not contain any substances designated as "conflict minerals" such as tantalum, tin, gold or tungsten from the Democratic Republic of Congo or adjacent countries.