

Tapered Levers • DIN 99

24470.0320



Product Description

Material

- Steel, blackened

Drawing

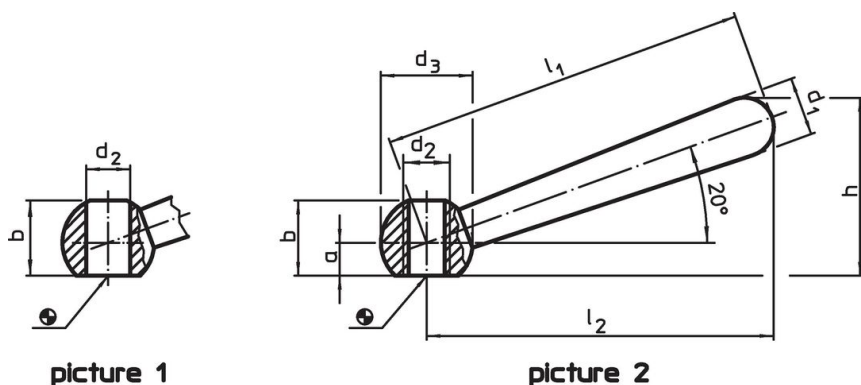

Order information

Dimensions								[g]	Art. No.
l_1	l_2	a	b	d_1	d_2	d_3	h		
[mm]									
slanted, with thread, form N – picture 2, Steel									
200	190	18	41	32	M24	50	97	1140	24470.0320

Application example



Compliance

RoHS compliant

Contains lead - compliant according to exceptions 6a / 6b / 6c.

Contains SVHC substances >0,1% w/w

Contains lead - SVHC list [REACH] as of 27.06.2024.

Contains Proposition 65 substances



Lead can cause cancer and reproductive harm from exposure
<https://www.P65Warnings.ca.gov/>

Free from Conflict Minerals

This product does not contain any substances designated as "conflict minerals" such as tantalum, tin, gold or tungsten from the Democratic Republic of Congo or adjacent countries.