

Machine Handles • DIN 39

24450.0032



Product Description

Material

- Steel, turned, zinc-plated by galvanization, passivated

Drawing

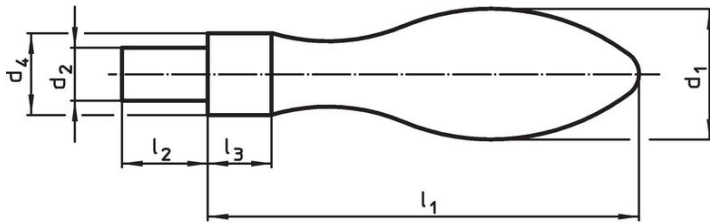

picture 1

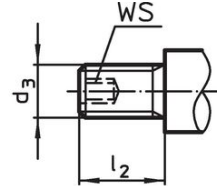

picture 2

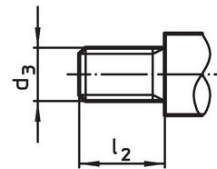

picture 3

Order information

Dimensions							[g]	Art. No.
d <sub>1</sub>	d <sub>2</sub> h8	d <sub>4</sub> h13	l <sub>1</sub>	l <sub>2</sub>	l <sub>3</sub>	[mm]		
with smooth lug, form D – picture 1, Steel								
32	13	20	100	21	13		356	24450.0032

Application example

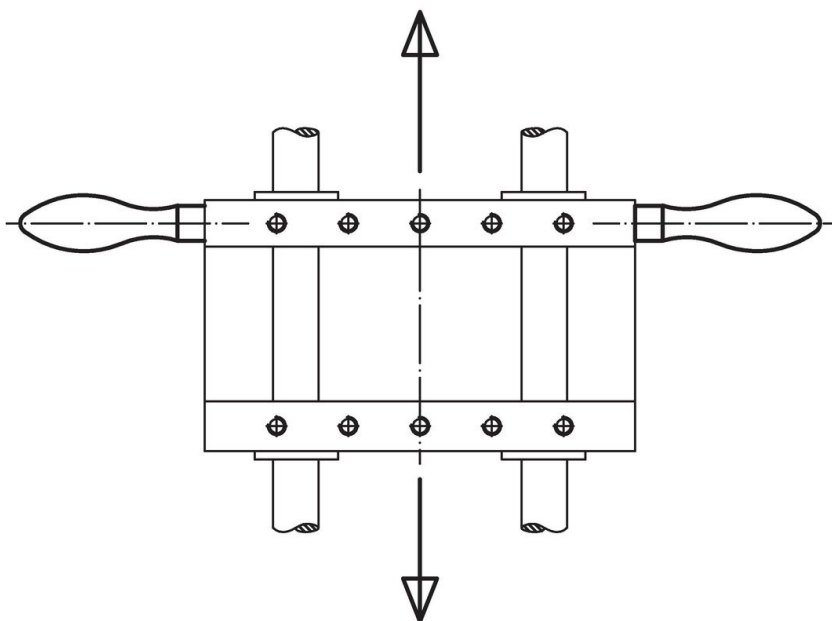

## Compliance

### RoHS compliant

Contains lead - compliant according to exceptions 6a / 6b / 6c.

### Contains SVHC substances >0,1% w/w

Contains lead - SVHC list [REACH] as of 23.01.2024.

### Contains Proposition 65 substances



Lead can cause cancer and reproductive harm from exposure

<https://www.P65Warnings.ca.gov/>

### Free from Conflict Minerals

This product does not contain any substances designated as "conflict minerals" such as tantalum, tin, gold or tungsten from the Democratic Republic of Congo or adjacent countries.