

Adjustable Tension Levers

24440.0710



Product Description

Material

Lever

- Stainless steel 1.4305, dull blasted

Screw

- Stainless steel 1.4305

Ball knob

- Thermosetting plastic PF 31, black, DIN 319

Operation

By lifting the lever the serrations are disengaged. The lever can be positioned by the serrations. On releasing the lever, the serrations are automatically re-engaged.

More information

Notes

The threaded portion can be exchanged.

Drawing

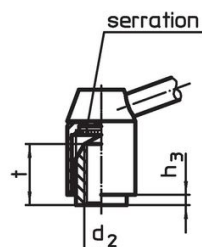
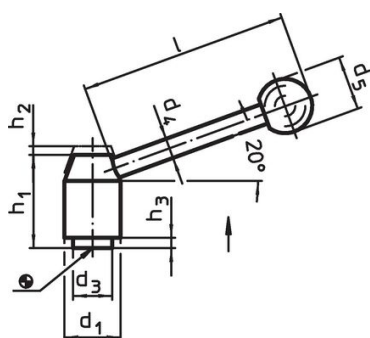

picture 1

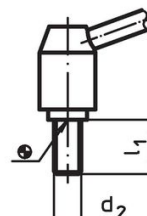

picture 2

Order information

d ₁	d ₂	l ₁	d ₃	Dimensions		h ₁	h ₂	h ₃	l	[g]	Art. No.
				d ₄	d ₅						
[mm]											
with screw – picture 2, Stainless steel											
21	M8	40	13.5	8	20	33.5	4	1	70	112	24440.0710

Compliance

RoHS compliant

Compliant according to Directive 2011/65/EU and Directive 2015/863.

Does not contain SVHC substances

No SVHC substances with more than 0.1% w/w contained - SVHC list [REACH] as of 23.01.2024.

Does not contain Proposition 65 substances

No Proposition 65 substances included.

<https://www.P65Warnings.ca.gov/>

Free from Conflict Minerals

This product does not contain any substances designated as "conflict minerals" such as tantalum, tin, gold or tungsten from the Democratic Republic of Congo or adjacent countries.