

Adjustable Tension Levers

24440.0430



Product Description

Material

Lever

- Steel, blackened

Inner parts

- Steel, blackened, quality 5.8

Screw

- Steel, blackened, quality 5.8

Ball knob

- Thermosetting plastic PF 31, black, DIN 319

Operation

By lifting the lever the serrations are disengaged. The lever can be positioned by the serrations. On releasing the lever, the serrations are automatically re-engaged.

More information

Notes

The threaded portion can be exchanged.

Drawing

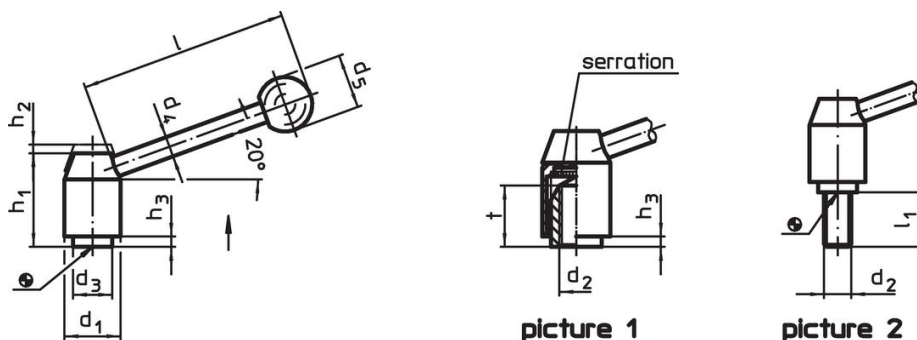

Order information

Dimensions										[g]	Art. No.
d ₁	d ₂	l ₁	d ₃	d ₄	d ₅	h ₁	h ₂	h ₃	l ₂		
[mm]											
with screw – picture 2, Steel											
33	M16	80	23	12	32	55	5.5	6	124	486	24440.0430

Compliance

RoHS compliant

Contains lead - compliant according to exceptions 6a / 6b / 6c.

Contains SVHC substances >0,1% w/w

Contains lead - SVHC list [REACH] as of 23.01.2024.

Contains Proposition 65 substances



Lead can cause cancer and reproductive harm from exposure
<https://www.P65Warnings.ca.gov/>

Free from Conflict Minerals

This product does not contain any substances designated as "conflict minerals" such as tantalum, tin, gold or tungsten from the Democratic Republic of Congo or adjacent countries.