

## Adjustable Clamping Levers · with screw

24400.0018



### Product Description

Adjustable clamping levers find versatile applications when the area of use is confined or a specific lever position is required.

### Material

#### Lever

- Zinc die-cast, plastic coated, orange similar to RAL 2004, matt structure

#### Inner parts

- Steel, blackened, quality 5.8

#### Screw

- Steel, blackened, quality 5.8

### Operation

**By lifting the lever** the serrations are disengaged. The lever can be positioned by the serrations. On releasing the lever, the serrations are automatically re-engaged.

### More information

### Notes

The screw part can be exchanged.

### Drawing

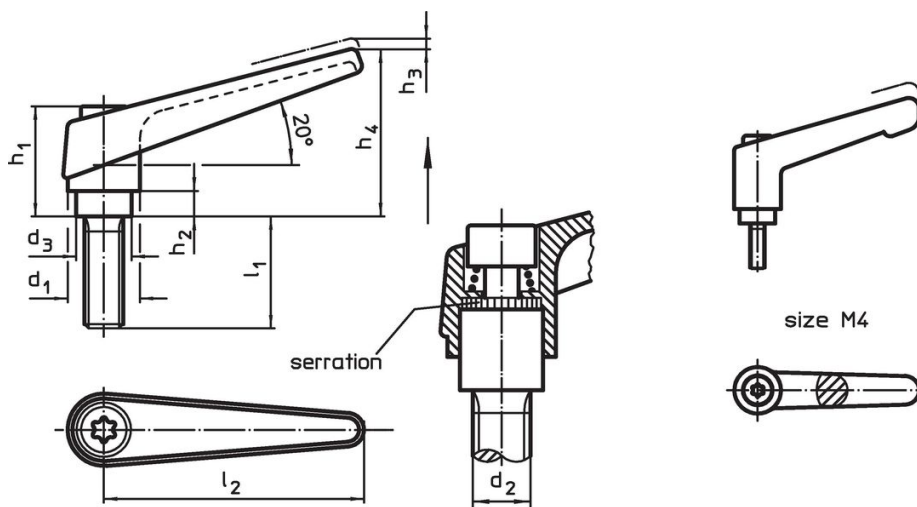

### Order information

Dimensions										Art. No.
$d_1$	$d_2$	$l_1$	$d_3$	$h_1$	$h_2$	$h_3$	$h_4$	$l_2$	[g]	
orange										
13	M4	20	10	24.5	4	3.5	30.5	30	28	24400.0018

### Application example

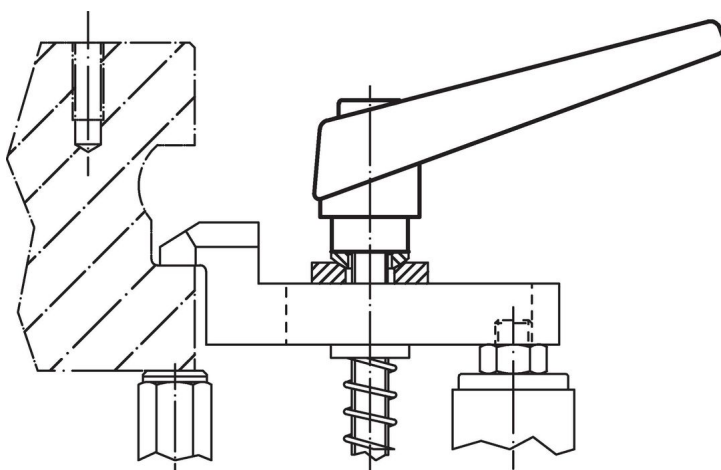

## Compliance

### RoHS compliant

Contains lead - compliant according to exceptions 6a / 6b / 6c.

### Contains SVHC substances >0,1% w/w

Contains lead - SVHC list [REACH] as of 27.06.2024.

### Contains Proposition 65 substances



Lead can cause cancer and reproductive harm from exposure  
<https://www.P65Warnings.ca.gov/>

### Free from Conflict Minerals

This product does not contain any substances designated as "conflict minerals" such as tantalum, tin, gold or tungsten from the Democratic Republic of Congo or adjacent countries.