

Crank Handles · with folding handle

24331.0005



Product Description

Material

Axle part

- Steel, blackened

Handle

- Thermoplastic, black, dull

Handle body

- Aluminium, plastic coated, similar to RAL 9006 silver, structural matt

Covering

- Plastic, light grey

Operation

In the operating position the handle is locked. To move the handle to the rest position, it must be pulled out axially and flipped round.

Drawing

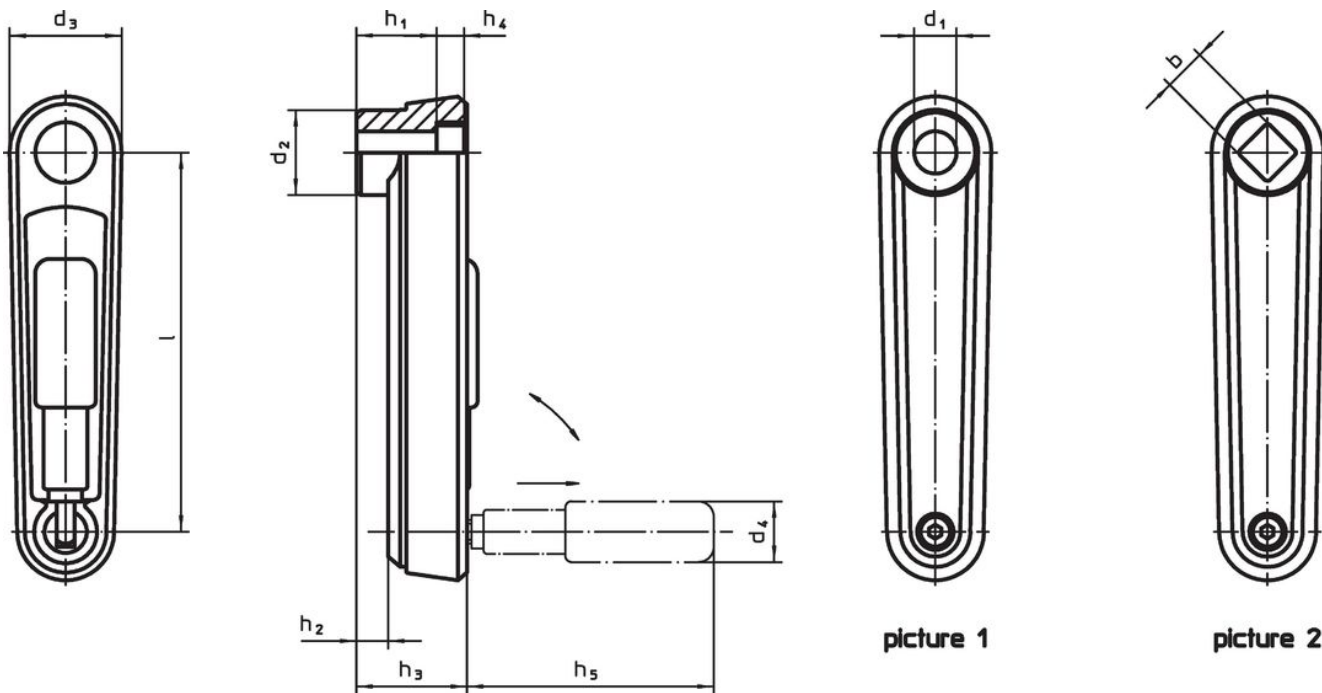

Order information

l	d ₁ H7	d ₂	d ₃	h ₁	Dimensions					d ₄ Cylindrical handle Ø	[g]	Art. No.
					h ₂ ~	h ₃	h ₄	h ₅	[mm]			
with smooth bore – picture 1, silver												
80	10	23	30	19.5	4	25.5	4.3	43	16	116	24331.0005	

Compliance

RoHS compliant

Contains lead - compliant according to exceptions 6a / 6b / 6c.

Contains SVHC substances >0,1% w/w

Contains lead - SVHC list [REACH] as of 23.01.2024.

Contains Proposition 65 substances



Lead can cause cancer and reproductive harm from exposure
<https://www.P65Warnings.ca.gov/>

Free from Conflict Minerals

This product does not contain any substances designated as "conflict minerals" such as tantalum, tin, gold or tungsten from the Democratic Republic of Congo or adjacent countries.