

Crank Handles · DIN 469 straight with square end DIN 79
24330.0050



Product Description

With these crank handles, the seam is ground and blasted. The hub is machined.

Material

Machine handle

- Steel, turned, zinc-plated by galvanization, passivated

Handle body

- Nodular cast iron, plastic coated, black

Drawing

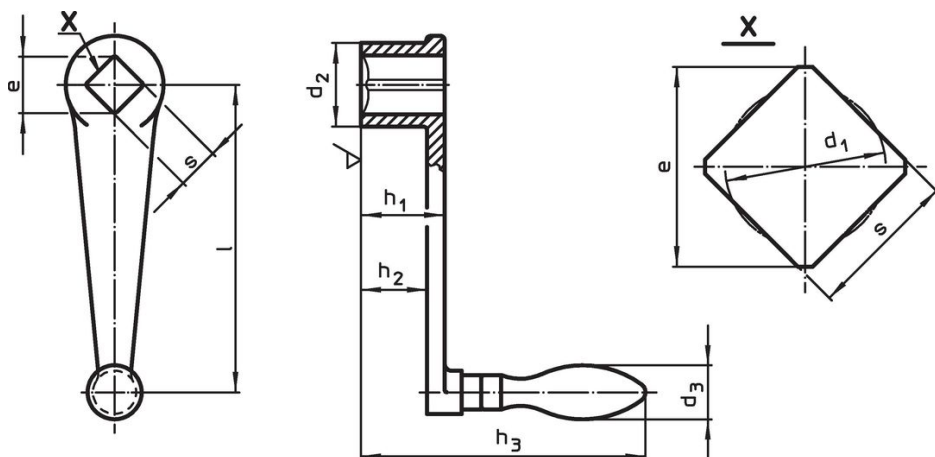

Order information

l	s H11	e min.	Dimensions					d ₃ Machine handle Ø	[g]	Art. No.
			d ₁	d ₂	h ₁	h ₂ ~	h ₃			
with rotating machine handle (EH 24460., DIN 98), form D										
160	17	22.2	17.9	38	38	29	126	25	667	24330.0050

Compliance

RoHS compliant

Compliant according to Directive 2011/65/EU and Directive 2015/863.

Does not contain SVHC substances

No SVHC substances with more than 0.1% w/w contained - SVHC list [REACH] as of 23.01.2024.

Does not contain Proposition 65 substances

No Proposition 65 substances included.

<https://www.P65Warnings.ca.gov/>

Free from Conflict Minerals

This product does not contain any substances designated as "conflict minerals" such as tantalum, tin, gold or tungsten from the Democratic Republic of Congo or adjacent countries.