

Tubular Handles • straight, front mounting

24321.0825



Product Description

Tubular handles are used, for example, on machine doors.

Material

Handle

- Zinc die-cast, plastic coated, black, similar to RAL 9005, matt structure

Handle shank

- Aluminium, plastic coated, similar to RAL 9005 black, matt structure

Cap

- Plastic, light grey

More information

Notes

Special types on request.

Drawing

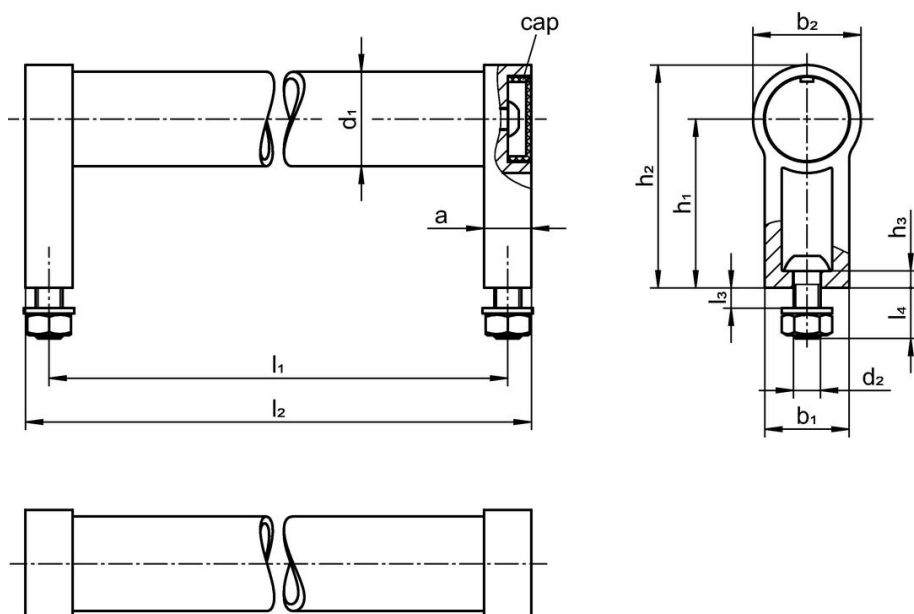

Order information

Dimensions								[g]	Art. No.
d ₁	l ₁ ±0.25	a	b ₁	d ₂	h ₁	h ₂	l ₂		
[mm]									
black similar to RAL 9005									
28	500	14	25	M6	50	66	514	480	24321.0825

Compliance

RoHS compliant

Compliant according to Directive 2011/65/EU and Directive 2015/863.

Does not contain SVHC substances

No SVHC substances with more than 0.1% w/w contained - SVHC list [REACH] as of 27.06.2024.

Does not contain Proposition 65 substances

No Proposition 65 substances included.

<https://www.P65Warnings.ca.gov/>

Free from Conflict Minerals

This product does not contain any substances designated as "conflict minerals" such as tantalum, tin, gold or tungsten from the Democratic Republic of Congo or adjacent countries.