

Tubular Handles • straight, front mounting

24321.0725



Product Description

Tubular handles are used, for example, on machine doors.

Material

Handle

- Zinc die-cast, plastic coated, silver, similar to RAL 9006, matt structure

Handle shank

- Aluminium, anodised

Cap

- Plastic, light grey

More information

Notes

Special types on request.

Drawing

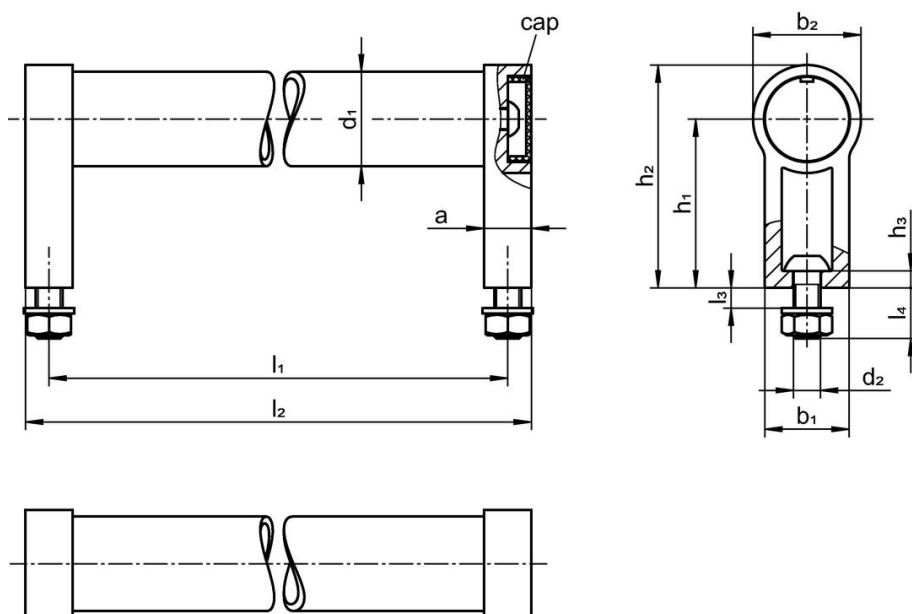

Order information

Dimensions								[g]	Art. No.
d_1	l_1 ± 0.25	a	b_1	d_2	h_1	h_2	l_2		
[mm]									
silver similar to RAL 9006									
28	500	14	25	M6	50	66	514	480	24321.0725

Compliance

RoHS compliant

Compliant according to Directive 2011/65/EU and Directive 2015/863.

Does not contain SVHC substances

No SVHC substances with more than 0.1% w/w contained - SVHC list [REACH] as of 23.01.2024.

Does not contain Proposition 65 substances

No Proposition 65 substances included.

<https://www.P65Warnings.ca.gov/>

Free from Conflict Minerals

This product does not contain any substances designated as "conflict minerals" such as tantalum, tin, gold or tungsten from the Democratic Republic of Congo or adjacent countries.