

## Tubular Handles • straight, front mounting

24321.0705



### Product Description

Tubular handles are used, for example, on machine doors.

### Material

#### Handle

- Zinc die-cast, plastic coated, silver, similar to RAL 9006, matt structure

#### Handle shank

- Aluminium, anodised

#### Cap

- Plastic, light grey

### More information

#### Notes

Special types on request.

### Drawing

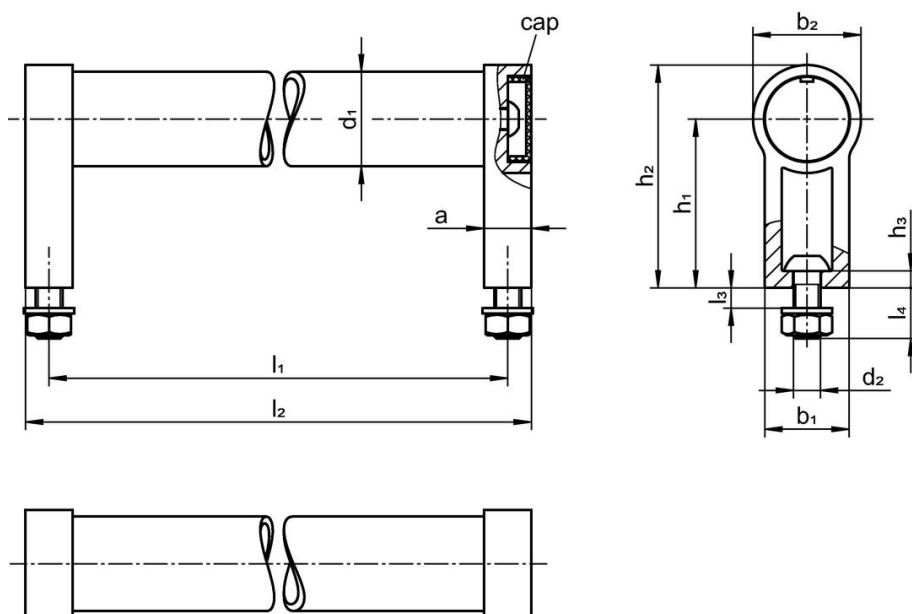

### Order information

Dimensions								[g]	Art. No.
$d_1$	$l_1$ $\pm 0.25$	$a$	$b_1$	$d_2$	$h_1$	$h_2$	$l_2$		
silver similar to RAL 9006									
28	250	14	25	M6	50	66	264	320	24321.0705

### Compliance

#### RoHS compliant

Compliant according to Directive 2011/65/EU and Directive 2015/863.

#### Does not contain SVHC substances

No SVHC substances with more than 0.1% w/w contained - SVHC list [REACH] as of 23.01.2024.

#### Does not contain Proposition 65 substances

No Proposition 65 substances included.

<https://www.P65Warnings.ca.gov/>

#### Free from Conflict Minerals

This product does not contain any substances designated as "conflict minerals" such as tantalum, tin, gold or tungsten from the Democratic Republic of Congo or adjacent countries.