

U-Handles • plastic

24320.0210



Product Description

U-handles are used, for example, on machine doors, furniture doors, cabinet doors, drawers and drawer units.

These U-handles made of glass fibre reinforced plastic are characterised by their ergonomic and stable construction and their simple and timeless design.

Material

Bushing

- Brass

Handle

- Thermoplastic PA, glass-fibre reinforced, black

Assembly

Back mount handle.

Drawing

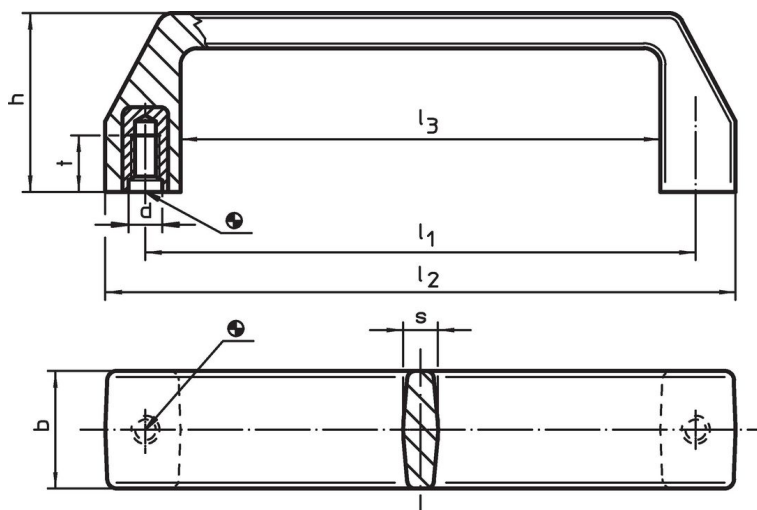

Order information

Dimensions								max. [°C]	[g]	Art. No.
$l_1$ $\pm 0.5$	d	b	h	$l_2$	$l_3$	s	t			
[mm]										
93.5	M6	21	36	107	79	6	10	100	31	24320.0210

Application example

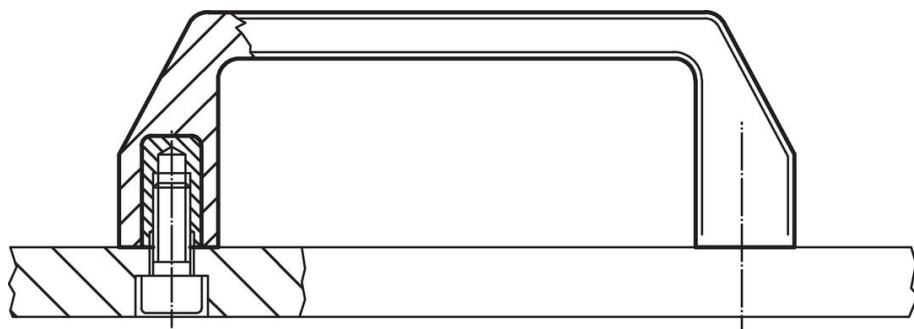

## Compliance

### RoHS compliant

Compliant according to Directive 2011/65/EU and Directive 2015/863.

### Does not contain SVHC substances

No SVHC substances with more than 0.1% w/w contained - SVHC list [REACH] as of 23.01.2024.

### Does not contain Proposition 65 substances

No Proposition 65 substances included.

<https://www.P65Warnings.ca.gov/>

### Free from Conflict Minerals

This product does not contain any substances designated as "conflict minerals" such as tantalum, tin, gold or tungsten from the Democratic Republic of Congo or adjacent countries.