

U-Handles
24300.0142



Product Description

U-handles are used, for example, on machine doors, furniture doors, cabinet doors, drawers and drawer units. These U-handles are characterised by their ergonomic profile design with very high stability and their simple and timeless design.

Material

Handle

- Aluminium, drawn, bright, vibratory grinded

Assembly

Back mount handle.

Drawing

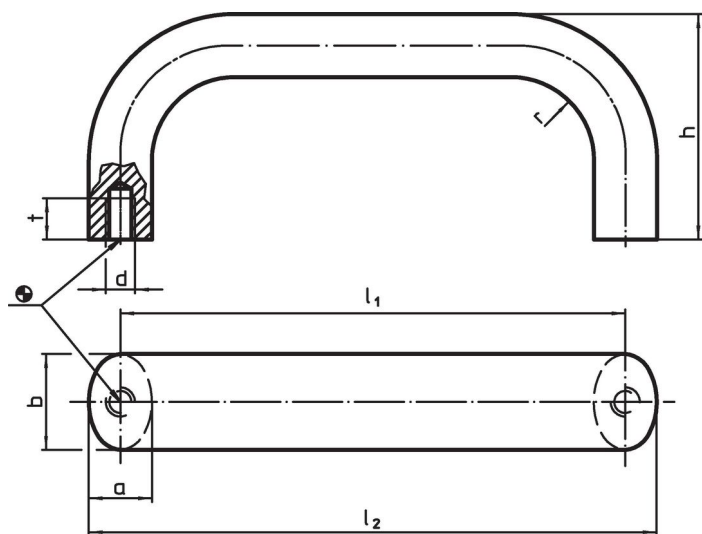

Order information

| b | l ₁ ±0.25 | l ₂ | Dimensions | | | | | [g] | Art. No. |
|---------------------------------|-------------------------|----------------|------------|----|----|----|----|-----|------------|
| | | | a | d | h | r | t | | |
| [mm] | | | | | | | | | |
| Aluminium, bright, Aluminium Al | | | | | | | | | |
| 26 | 117 | 134 | 17 | M8 | 55 | 17 | 12 | 166 | 24300.0142 |

Application example



Compliance

RoHS compliant

Compliant according to Directive 2011/65/EU and Directive 2015/863.

Does not contain SVHC substances

No SVHC substances with more than 0.1% w/w contained - SVHC list [REACH] as of 23.01.2024.

Does not contain Proposition 65 substances

No Proposition 65 substances included.

<https://www.P65Warnings.ca.gov/>

Free from Conflict Minerals

This product does not contain any substances designated as "conflict minerals" such as tantalum, tin, gold or tungsten from the Democratic Republic of Congo or adjacent countries.