

## Retaining Latches · one-sided

24100.0102



### Product Description

To be used for door locking, drawers and as handling aid etc.  
The retaining catch is indexing 4 x 90°.

### Material

#### Lever

- Zinc die-cast, black, similar to RAL 9005

#### Inner parts

- Dry powdered metal

#### Screw

- Stainless steel A2 (ISO 10642)

### Drawing

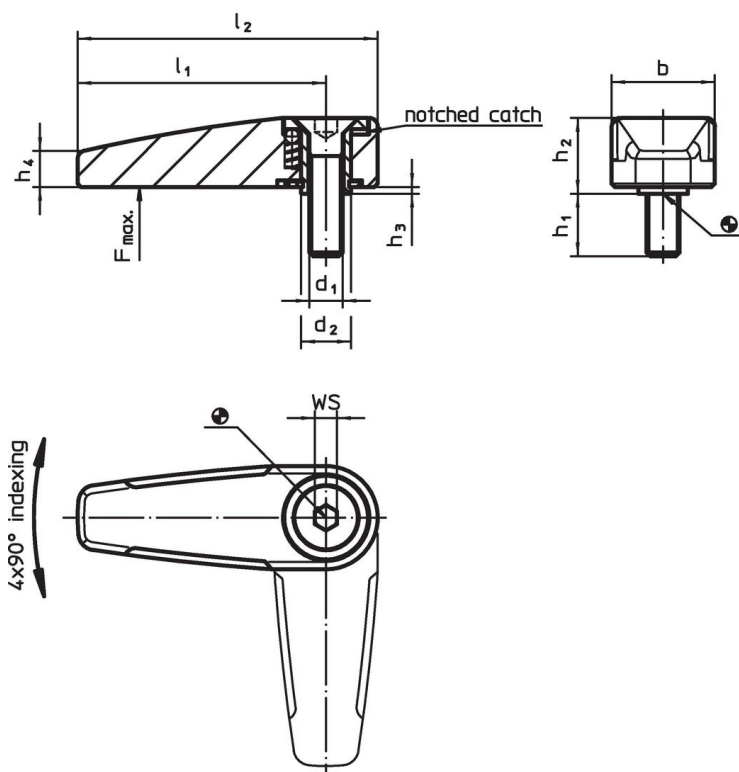

### Order information

Dimensions										WS	Load capacity max.		Art. No.
d <sub>1</sub>	d <sub>2</sub>	l <sub>1</sub>	l <sub>2</sub>	b	h <sub>1</sub>	h <sub>2</sub>	h <sub>3</sub>	h <sub>4</sub>	[mm]				
black													
M6	9	45	55	19	12	13.3	0.8	6.5	4	500	60	24100.0102	

## Application example

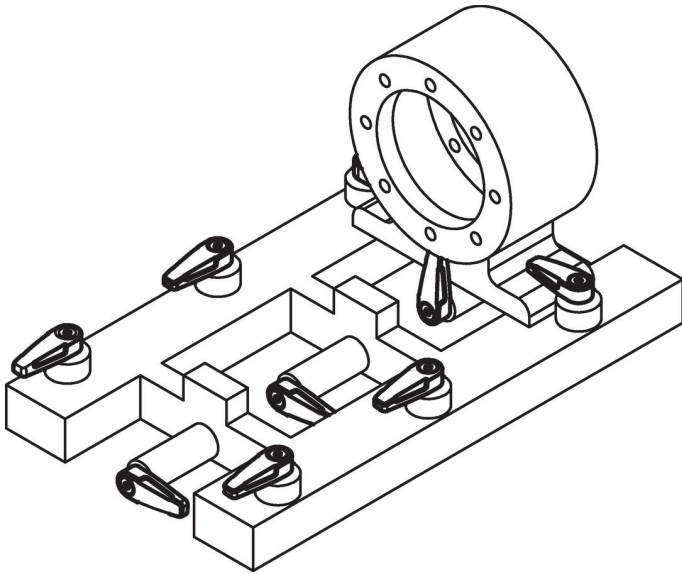

## Compliance

### RoHS compliant

Compliant according to Directive 2011/65/EU and Directive 2015/863.

### Does not contain SVHC substances

No SVHC substances with more than 0.1% w/w contained - SVHC list [REACH] as of 23.01.2024.

### Does not contain Proposition 65 substances

No Proposition 65 substances included.

<https://www.P65Warnings.ca.gov/>

### Free from Conflict Minerals

This product does not contain any substances designated as "conflict minerals" such as tantalum, tin, gold or tungsten from the Democratic Republic of Congo or adjacent countries.